



OptoMonitor 3

REF F2300 series System

Instructions for Use

en: Instructions for Use

CONTENTS

1	INTRODUCTION	10
1.1	Indications for Use.....	11
1.1.1	Intended user	11
1.1.2	Intended environment	11
1.2	Contraindications	11
1.3	Safety.....	11
1.3.1	Warnings.....	11
1.3.2	Cautions.....	12
1.3.3	Precautions.....	14
1.3.4	Notes	14
1.4	Storage and Handling	15
1.5	Symbols.....	15
1.6	Cybersecurity.....	18
2	COMPLIANCE WITH REGULATORY REQUIREMENTS	19
2.1	Compliance with Standards and Directives.....	19
2.2	RF Compliance	25
2.2.1	United States	25
2.2.2	Canada	26
2.2.3	Japan.....	26
2.3	Essential performance.....	26
2.4	Deviation from the standards.....	26
3	OVERVIEW OF THE OPTOMONITOR 3 SYSTEM	27
3.1	OptoMonitor 3 Optical Unit (OpM3-OU)	28
3.2	Cathlab Interface Cables.....	29
3.2.1	AUX In (AUX Interface Cable)	29
3.2.2	Aortic In (Ao Transducer Interface Cable)	29
3.2.3	Aortic Out Cable (Pressure Output Interface Cable)	29
3.2.4	Distal Out (Pressure Output Interface Cable).....	29

3.3	OptoMonitor 3 Display Unit (OpM3-DU).....	29
3.3.1	Overview of the DU	29
3.4	OptoMonitor 3 Handle Unit (OpM3-HU).....	31
3.5	Accessories	31
3.5.1	OptoWire™ Pressure Guidewire (not supplied)	31
3.5.2	SavvyWire™ Pressure Guidewire (not supplied)	31
3.5.3	Aortic transducer (supplied by others).....	32
3.6	Audio and LED Indicators.....	32
3.6.1	Audio Indicators.....	32
3.6.2	Color Indicators	33
3.7	Graphical User Interface.....	35
3.8	Coronary procedure main Menu Screen Functions	37
3.9	Structural procedure main Menu Screen Functions	39
3.10	Playback Mode Functions.....	40
3.10.1	Universal Menu Functions.....	43
3.10.2	Archive Menu Functions.....	45
4	OPTOMONITOR 3 INSTALLATION	47
4.1	Unpacking the OptoMonitor 3 System.....	48
4.2	Mounting the devices.....	48
4.2.1	Mounting the devices.....	48
4.2.2	Mounting the Optical Unit.....	48
4.2.3	Mounting the Display Unit	48
4.3	Connecting the Handle Unit	49
4.4	Connecting to Mains Supply.....	50
4.5	Connecting to Cathlab Hemodynamic High-Level Aortic Output.....	50
4.6	Connecting to Aortic Transducer (Aortic Input)	51
4.7	Connecting Aortic Output to Cathlab Hemodynamic- compulsory when using the Ao transducer interface cable.....	51
4.8	Connecting Distal Output to Cathlab Hemodynamic- Optional	51

4.9	Connecting DICOM	52
4.10	Connecting an external screen	53
4.11	Connecting a wireless mouse	53
5	INSTRUMENT SETTINGS.....	55
5.1	dPR Mode	56
5.1.1	dPR Disabled	56
5.1.2	dPR Enabled.....	56
5.2	TAVI Mode.....	57
5.3	Prospective Equalization	57
5.4	Hide Patient Info.....	58
5.5	Show ECG.....	59
5.6	Pressure Scale.....	59
5.7	Time Scale.....	60
5.8	Pullback Time Scale	60
5.9	Color Selection.....	61
5.10	Audio and Brightness level	61
5.11	Averaging period	62
5.12	Pressure Wire Delay	63
5.13	Input/Output Calibration with Cathlab Hemodynamic System, and Time/Date/Language Adjustments via the Maintenance Menu.....	64
5.13.1	Accessing the Input/Output Calibration Menu	64
5.13.2	Adjusting Time, Date and Language	65
5.14	Activation Key.....	66
5.14.1	Activation card.....	66
5.14.2	Activation Management menu.....	66
5.14.3	Activating the software	67
5.14.4	Edit or remove the activation key	67
6	PATIENT CASE MANAGEMENT	68
6.1	Opening a New Case.....	68

6.1.1	Opening a New Case Without DICOM	68
6.1.2	Opening a New Case from DICOM List	69
6.1.3	Refreshing the DICOM list	70
6.2	Ending an Open Case/ Starting a Second Case	70
7	PERFORMING a PROCEDURE	72
7.1	Starting the System	74
7.2	Verifying Optimal Aortic Pressure Waveform and ensuring Ao Zero.....	75
7.2.1	Using Aortic Input from Cathlab Hemodynamic System.....	75
7.2.2	Using Aortic Input from the Aortic Transducer (Use with BP-22 compatible transducer)	75
7.3	Connect the FOIC Connector to the OptoMonitor 3 Handle Unit.....	76
7.4	Zeroing pressure guidewire to Atmosphere.....	76
7.4.1	Automatic Zero	76
7.4.2	Manual Zero	76
7.5	Equalization	77
7.5.1	FFR/dPR procedure equalization	77
7.5.2	TAVI procedure equalization	78
7.6	Performing an FFR Procedure	79
7.6.1	Inducing Maximum Hyperemia	79
7.6.2	Recording Pressure – FFR	79
7.7	Performing a dPR Procedure	80
7.7.1	dPR Calculation.....	80
7.7.2	Performing a dPR Pullback	80
7.8	Viewing FFR, dPR, and Pullback in Playback Mode	81
7.8.1	Viewing FFR in Playback Mode	81
7.8.2	Viewing dPR in Playback Mode	83
7.8.3	Viewing dPR Pullback in Playback Mode	84
7.8.4	Viewing Pd/Pa Pullback in Playback Mode.....	85
7.9	Performing TAVI procedure.....	85
7.9.1	When to record	85

7.9.2	Recording Pressure – TAVI.....	85
7.9.3	Viewing TAVI in Playback Mode	86
7.9.4	Select indices period.....	87
7.9.5	Select pressure wire delay.....	87
7.9.6	Compare/View screen	88
7.9.7	Playback Gradients and regurgitation indicators	88
7.10	Playback functions.....	90
7.10.1	Creating or Updating Patient Information	90
7.10.2	FFR/dPR Notes	91
7.10.3	TAVI Notes	93
7.10.4	Reviewing Data	95
7.10.5	Archiving and deleting data.....	96
7.11	Terminate Operation	97
8	MAINTENANCE	97
8.1	Accessing the Maintenance Menu	98
8.2	Adjusting the Time, Date, and Language.....	98
8.3	Input/output Calibration with Cathlab Hemodynamic System	99
8.3.1	Calibrating Aortic Input Reference to Aortic Transducer	100
8.3.2	Calibrating Aux Input Reference to Cathlab Hemodynamic System	100
8.3.3	Calibrating Distal Output to Cathlab Hemodynamic System	100
8.3.4	Calibrating Aortic Output to Cathlab System	101
8.4	Reviewing Optical Sensor Performance	101
8.5	Testing DICOM.....	102
8.5.1	Testing DICOM.....	103
8.5.2	Filtering the Modality Worklist.....	103
8.5.3	Display information on the Exported Images.....	104
8.6	Security.....	104
8.6.1	Setting up a Startup Password	104
8.6.2	Changing the Maintenance Access Code.....	104
8.7	Reviewing Message History.....	105

8.8	Reviewing Network and Communication.....	105
8.8.1	DU LAN1 connection to DICOM.....	105
8.8.2	DU-15" LAN2 connection to the Optical unit	105
8.8.3	Wireless	106
8.9	Software Update for Display Unit or Optical Unit	107
8.10	Factory Settings	108
8.11	DUMP Logs	108
8.12	Adjustable settings	109
8.12.1	SETTINGS MENU	109
8.12.2	MAINTENANCE MENU Input/Output Calibration.....	109
8.12.3	MAINTENANCE MENU Security	111
8.12.4	MAINTENANCE MENU Network and Communication	111
9	FIELD SERVICE INFORMATION	111
10	GENERAL CARE AND CLEANING.....	112
10.1	Cleaning	112
10.1.1	Optical Unit and Display Unit	112
10.1.2	Handle Unit.....	113
10.1.3	Optical Connectors	113
10.2	Leakage Current Measurement.....	114
10.3	Visual Inspection.....	114
10.3.1	General Routine Inspection.....	114
10.3.2	Annual Visual Inspection	115
10.4	Disposal	115
11	TROUBLESHOOTING	115
11.1	Verify the Connection of the pressure guidewire	115
11.2	Zeroing Failed	116
11.3	Wire Zeroed Twice.....	116
11.4	Aortic Input Zeroing Failed	116
11.5	Equalization Failed.....	117

11.6 Pressure Wire Delay messages.....	117
11.7 Re-Equalized	118
11.8 GFC and OptoWire™ Mismatch.....	118
12 SPECIFICATIONS.....	118
12.1 Technical Specifications.....	118
13 ORDERING INFORMATION.....	121
14 OPTOMONITOR 3 SYSTEM LOG – DISTAL INPUT VALUE	122
15 Appendix A: OptoMonitor 3 Installation Instructions	123
16 Parameters	128
17 AUX In Calibration Using the OptoMonitor 3 and Cathlab Hemodynamic System.....	128
18 Pa Input Calibration Using OptoMonitor 3 and Aortic Transducer	128
19 Pd Output Calibration.....	129
20 Aortic Output Calibration	129
21 Installation Acknowledgement.....	130
22 Appendix B- Installation Checklist	131

DISCLAIMER OF WARRANTY

OpSens Inc. warrants that reasonable care has been used in the design and manufacture of this instrument. System manufactured by OpSens is warranted to be free of defects in materials and workmanship for a period of one year from the date of shipment.

This warranty is in lieu of and excludes all other warranties not expressly set forth herein, whether express or implied, written, or oral, by operation of law or otherwise, including, but not limited to, any implied warranties as to the condition, quality, durability, performance, merchantability or fitness for a particular purpose.

OpSens Inc. has no control over the conditions under which this instrument is used. Handling, storage, and cleaning of this instrument as well as other factors relating to the patient, diagnosis, treatment, surgical procedures, and other matters beyond OpSens' control directly affect the instrument and the results obtained from its use. OpSens assumes no liability with respect to instruments reused, reprocessed or re-sterilized.

OpSens' obligation under this warranty is limited to the repair or replacement of this instrument. However, OpSens may, at its sole discretion, replace any instrument that is determined to have been out of specification at the time of shipment. OpSens shall not be liable for any incidental or consequential loss, damage, or expense directly or indirectly from the use of this instrument. OpSens neither assumes, nor authorizes any other person to assume for it, any other or additional liability or responsibility in connection with this instrument; no person has authority to bind OpSens to any representation, warranty, or liability except as set forth in this Disclaimer of Warranty. OpSens Inc. shall not be liable to any person or entity for any medical expenses, any loss or injury to a party's profits or goodwill or any direct, incidental, consequential, special, punitive, or exemplary damages caused by, arising from, or related to any use, defect, failure or malfunction of the instrument, whether a claim for such damages is based upon warranty, contract, tort or otherwise.

The exclusions, disclaimers, and limitations set forth in this Disclaimer of Warranty are not intended to, and shall not be construed as to, contravene mandatory provisions of any applicable law or regulation. If any part of this Disclaimer of Warranty is held to be illegal or unenforceable by a court of competent jurisdiction, the part shall be modified to be enforceable to the maximum extent possible. If the part cannot be modified, then that part may be severed, and the other parts of this Disclaimer of Warranty shall remain in full force and effect.

1 INTRODUCTION

Carefully read and review this entire manual to fully understand the device, its operation, and the potential risks to user and patient before use of the OptoMonitor 3 System. Illustrations shown in this manual are intended to familiarize the user with the device. All illustrations in this manual serve as examples only. They may not necessarily reflect the data displayed on your OptoMonitor 3.

Rx Only

Caution: Applicable laws restrict this device to sale by, or on the order of, a licensed healthcare practitioner.

Product description

The OptoMonitor 3 – OptoWire™ pressure guidewire combination connected to a Cathlab Hemodynamic System or aortic transducer, is intended to be used or supervised by cardiologists in catheterization laboratories for intravascular blood pressure measurement such as the FFR and dPR measurement.

The OptoMonitor 3 – SavvyWire™ pressure guidewire combination connected to a Cathlab Hemodynamic System or aortic transducer, is intended to be used or supervised by cardiologists in catheterization laboratories for blood pressure measurement such as the gradients and regurgitation indices measurement.

The OptoMonitor 3 computes and displays information, based on the input from the OpSens pressure guidewire, an Aortic Pressure transducer (Ao) and optionally an ECG curve. The pressure data is displayed as graphical curves and numerical values on the OptoMonitor 3 Display Unit (OpM3-DU) screen.

For coronary procedures, data includes real-time and mean Aortic (Pa) and Distal (Pd) blood pressures, Pd/Pa, diastolic pressure ratio (dPR), Fractional Flow Reserve (FFR) and optionally an ECG curve.

For structural procedures, data includes: real-time and systolic/diastolic Aortic (Ao) and wire (LV) blood pressures, pulse rate, left-ventricular end of diastole pressure, gradients, regurgitation indices and optionally an ECG curve.

An analog output is provided to send distal pressure to the Cathlab Hemodynamic System.

An analog output is provided to send aortic pressure to the Cathlab Hemodynamic System.

In addition, the FFR value can be sent to the Cathlab Hemodynamic System over the distal pressure analog output.

The OptoMonitor 3 consists of the following components:

1. OptoMonitor 3 Optical Unit (OpM3-OU) REF F2310
2. OptoMonitor 3 Display Unit 10" (OpM3- DU) REF F2320 or
OptoMonitor 3 Display Unit 15" (OpM3-DU) REF F2321

3. OptoMonitor 3 Handle Unit (HU) REF F2330
4. OptoMonitor 3 DU Wireless dongle REF F2322
5. OU Power supply 30 W 12 V 2.5 A REF F201003
6. DU Power Supply cable
7. AC power cord country specific power cord wall adapter
8. OptoMonitor 3 DU-OU communication cable REF F232009
9. OptoMonitor 3 DU-OU communication LAN cable REF F232010
10. AUX interface cable from hemodynamic system output
11. Pressure output cable to hemodynamic system input
12. Aortic Transducer interface cable

1.1 Indications for Use

The OptoMonitor 3 is intended to measure cardiovascular blood pressure, including in heart chambers, coronary vessels, and peripheral vessels, during interventional procedures.

Blood pressure measurements provide hemodynamic information, such as fractional flow reserve for the diagnosis and treatment of blood vessels and such as valve gradients during structural heart procedures.

1.1.1 Intended user

The OptoMonitor 3 is intended to be used or supervised by cardiologists.

1.1.2 Intended environment

The OptoMonitor 3 is intended to be used in catheterization laboratories.

1.2 Contraindications

The system has no patient alarm functions. Do not use for cardiac monitoring. The system is contraindicated for use in cerebral vasculature.

1.3 Safety

1.3.1 Warnings

- Before putting the system into operation, the operator must verify that the equipment, connecting cables and accessories are in correct working order and operating condition.
- The power supply and cord used with the OptoMonitor 3 must be supplied by OpSens or personnel authorized by OpSens to ensure compliance with local standards.
- To avoid explosion hazard, do not use the equipment in the presence of flammable anesthetics mixture with oxygen or nitrous oxide, vapors, or liquids.
- No modification of this equipment is allowed. Do not open the OptoMonitor 3 housings. All servicing and future upgrades must be carried out by the personnel trained and authorized by OpSens only.
- Do not use OptoMonitor 3 if it has been dropped or in another way exposed to mechanical or electrical damage or if liquids have penetrated the housing. The user or patient may be exposed to electrical shock or faulty readings may appear. In the event of system damage,

- turn the system off; unplug the system from the power outlet and contact a qualified field service person and/or OpSens authorized service person or OpSens.
- In the event of any anomalies observed on system, accessories, or labels, please contact a qualified field service person and/or OpSens authorized service person or OpSens.
 - The OptoMonitor 3 has no patient alarm functions. The audio indicator is for system status indications only.
 - To avoid inadvertent disconnection, route all cables and secure excess cabling in a way to prevent a stumbling and entanglement hazard.
 - Power supply is specified as a part of the equipment or combination is specified as a me system. Connection of equipment that do not follow relevant IEC standard for medical equipment (e.g. IEC 60601) may lead to patient injury or death.
 - Always keep portable RF communications equipment (including peripherals such as antenna cables and external antennas) at least 30 cm (12 inches) from any part of the OptoMonitor 3, including cables specified by the manufacturer. Otherwise, degradation of the performance of this equipment could result.
 - The OptoMonitor 3 system is designed to be used nearby all devices that could potentially be installed nearby to the location of its INTENDED use.
 - OptoMonitor 3 cannot be used in homecare environment. This device is intended to be used in properly equipped healthcare facilities, such as a Cathlab.
 - Other equipment should not be stacked on-top of or in direct-contact with the OptoMonitor 3 system, otherwise there is risk of improper operation. If such use is necessary, this equipment and the other equipment should be observed to verify that they are operating normally.
 - Use of accessories, transducers, and cables other than those specified or provided by the manufacturer of this equipment could result in increased electromagnetic emissions or decreased electromagnetic immunity of this equipment and result in improper operation.
 - Improper installation of the OptoMonitor 3 or other equipment may lead to interference of OptoMonitor 3 function, even if that other equipment complies with CISPR EMISSION requirements.
 - When connecting to healthcare facility network, such as DICOM, connection shall be isolated.
 - When connecting video output signal to an external device, connection shall be made with a shielded cable. Connection shall also be isolated to provide protection against leaking current. The user is responsible for compliance with the requirements of standard IEC 60601-1.
 - OpM3 system must not be serviced or maintained while in use with the patient
 - Assembly of OptoMonitor as part of a Medical Equipment System as well as modifications during actual service life shall be evaluated based on the requirements of IEC-60601-1

1.3.2 Cautions

- To ensure patient safety, use only parts and accessories specified in this manual.

- At the end of its service life, the equipment, as well as its accessories, must be disposed of in compliance with the guidelines regulating the disposal of such products. If you have any questions concerning disposal of the equipment, please contact OpSens or personnel authorized by OpSens.
- Radio transmitting equipment, cellular phones, and strong emission sources such as high frequency surgical equipment are capable of interfering with the proper performance of the equipment. For this reason, make sure that all external devices operated in the vicinity of the OptoMonitor 3 comply with the relevant EMC requirements.
- Before connecting the equipment to the power line, check that the voltage and frequency ratings of the power line are the same as those indicated on the OptoMonitor 3 label or in this manual.
- Always install or carry the equipment properly to avoid damage caused by drop, impact, strong vibration, or other mechanical force.
- Maintain at least 5 cm (2") of clearance above the Optical Unit to ensure proper ventilation.
- Always leave the protective caps on the optical connector on the Handle Unit when the system is not in use. Do not put any sharp object into the optical connector.
- Only OpSens' pressure guidewire is intended to be connected to the optical connector on the Handle Unit.
- Each pressure guidewire is matched with its unique cable and Gauge Factor Connector (where applicable) supplied in the same package. OpSens' pressure guidewire cable and Gauge Factor Connector (where applicable) must be inserted into the Handle Unit to allow proper operation.
- External equipment intended for connection to Pa INPUT, Pa/Pd OUTPUT or other connectors, shall comply with relevant IEC standard (e.g. IEC 60601 series for medical electrical equipment).
- Ensure the interface cables delivered with OptoMonitor 3 are compatible with the Cathlab Hemodynamic System which is to be used with the OptoMonitor 3.
- Ensure to set proper pressure averaging (see section 5.11).
- OptoMonitor 3 is protected against the effects of a discharge of a defibrillator. Readings may be temporarily affected by defibrillation.
- Ensure OptoMonitor 3 Handle Unit is not used in sterile environment.
- Ensure OptoMonitor 3 is within operating temperatures (15 – 30 °C / 59 – 86 °F) prior to the procedure. If OptoMonitor 3 is outside of its normal operating temperatures, it may not function normally.
- Connection to IT-NEWORKS including other equipment could result in previously unidentified risk to patients, operator or third parties. Responsible organization should identify, analyze, evaluate, and control these risks.
- The following changes to IT-Network could introduce new risks that require additional analysis: changes in network configuration, connection of additional items, disconnection of items, update of equipment and upgrade of equipment.

- Hemodynamics parameters such as Aortic Regurgitation Index alone cannot provide basis for clinical decision and their interpretation is left to physicians. Values should be interpreted by comparing pre- to post-procedural measurements, along with other information available such as imaging modalities.

1.3.3 Precautions

To protect the privacy and security of sensitive information, including electronic protected health information (EPHI), and to protect the integrity of the system itself, the system should be located in a physically secure, access-controlled environment.

1.3.4 Notes

- A warmup period (approximately 20 minutes) before the procedure is recommended.
- Put the equipment in a location where you can easily see the screen and access the operating controls. It is up to the user's discretion to determine if the ideal display unit location is a wired-bedside setup or a wireless-control room setup.
- Keep this manual in the vicinity of the equipment so that it can be obtained conveniently when needed.
- NOTE: The EMISSIONS characteristics of this equipment make it suitable for use in industrial areas and healthcare facilities (CISPR 11 class A). If it is used in a residential environment (for which CISPR 11 class B is normally required) this equipment might not offer adequate protection to radio-frequency communication services. The user might need to take mitigation measures, such as relocating or re-orienting the equipment.
- This device may use *Bluetooth*[®] 2.1+ EDR communication. The frequency band of this technology is between 2400 MHz and 2483.5 MHz. Type and frequency characteristics of the modulation is FHSS/GFSK. Effective radiated power is 2.5 mW, *Bluetooth*[®] Class 2.
- Portable and mobile RF communications equipment can affect OptoMonitor 3.
- OptoMonitor 3 needs special precautions regarding EMC and needs to be installed and put into service according to the EMC information provided in the manual.
- Any serious incident that occurs in relation to the device should be reported to the manufacturer and the competent authority
- Since there is no conductive lead between the OpM3 and the OpSens pressure wires (optical connection only), the OpM3 system does not add any additional danger during the use of HF surgical equipment. For the aortic transducer input, please refer to the transducer manual for this information. The measurement taken by the OpM3 shall not be used during the use of a HF surgical equipment on the patient.
- Since there is no conductive lead between the OpM3 and the OpSens pressure wires (optical connection only), the OpM3 system does not add any additional danger during the defibrillation of a patient. For the aortic transducer input, please refer to the transducer manual for this information. The measurement taken by the OpM3 shall not be used during the use of a defibrillator on the patient.

- This device should not be used in proximity to known sources of electromagnetic disturbance such as diathermy, electrocautery, RFID, etc. as this equipment has not been tested for immunity to specific sources of electromagnetic disturbance.
- Take the following precautions to prevent any adverse events to the patient and/or to the user in case of electromagnetic disturbances:
 - Always refer to the information listed in the section 2.1 Compliance with Standards and Directives.
 - In case of a signal noise, presumably caused by electromagnetic disturbances, first verify the cabling, and then move any portable RF communications equipment and mobile devices placed nearby as far away as possible to rule out interference.
 - If signal noise persists, move any nearby portable equipment even if it is not expected to be an RF emitter as some RF emitters (e.g. RFID) might be concealed.
 - Stop using the device if the electromagnetic disturbances persist and contact a qualified field service person and/or OpSens authorized service person or OpSens for assistance.

1.4 Storage and Handling

The OptoMonitor 3 is shipped non-sterile and must not be sterilized.

- Store system components in a clean environment away from humidity, magnets, and sources of electromagnetic interference (EMI).
- System performance may be affected if OptoMonitor 3 is exposed to temperatures outside the range showed in the symbols in section 1.5.
- Components should not be used if they have been subjected to temperatures exceeding safe storage and handling ranges.

Do not use OptoMonitor 3 components if it was dropped onto a hard surface from higher than 12 inches (30.0 cm), because the system may be damaged and fail to operate properly.

1.5 Symbols

The symbols below may be found in these operating instructions or on the OptoMonitor 3 system, its accessories, packaging, or training tools.

Rx only

Caution: Applicable laws restrict this device to sale by or on the order of a licensed healthcare practitioner. Only physicians or other persons with adequate medical training in catheter insertion procedures should use the OpSens OptoMonitor 3 system. Only those personnel who are familiar with its operation and who have been trained to perform the procedures for which the device is intended should use the system



Follow instructions for use

IPX0 / IPX 2

IPX0 rating: Limited protection against ingress of water

IPX2 rating: Protected against vertically falling drops of water



This marking indicates that this product should not be disposed with other household wastes throughout the EU. To prevent possible harm to the environment or human health from uncontrolled waste disposal, recycle it responsibly to promote the sustainable reuse of material resources. To return your used device, please use the return and collection systems or contact the retailer where the product was purchased. They can take this product for environmentally safe recycling

Distal Out

Pd Output to Cathlab Hemodynamic System

Aortic Out

Pa Output to Cathlab Hemodynamic System

Aux In

Pa Input/ECG Input from Cathlab Hemodynamic System

**Aortic
Transducer**

Pa Input from Aortic Transducer



Power button



Direct current



Defibrillation-proof type CF applied part



Keep dry

REF













System model number

SN

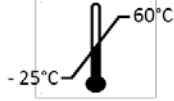
System serial number

LOT

LOT number

	YYYY-MM	Date of manufacture; expressed in Year and Month
		Manufacturer
		Authorized European representative
		Australian sponsor
		Authorized representative for Switzerland
		Relative humidity range for storage condition and system use
		Atmospheric pressure range for storage condition
		Temperature range for storage condition
		Stacking limit
		This side up
		Fragile
		Handle with care
		Single use. This symbol applies only to OpSens' pressure guidewires



Indicates equipment which emits radio-frequency signal.



Indicates equipment not to be used in MRI scanner room.



Indicates that an activation code is needed to use a software feature.



Medical device

1.6 Cybersecurity

- OpSens makes no representation of warranty that use of the OptoMonitor complies with applicable laws and regulations concerning data privacy, security, and confidentiality. OptoMonitor needs to be evaluated as a component of your system as you use, control, process or transfer patient health information.
- It is hospital responsibility to ensure proper decommissioning process is followed with regard to patient information stored on device.
- Access codes and passwords change frequency should be aligned with local hospital password policies.
- To protect the integrity of the device as well as the privacy and security of sensitive information, the system should be located in an access-controlled environment. Use of Locking password (ref section 8.6.1) is recommended. Locking delay should be aligned with local hospital password policies.
- Access codes and passwords are activated by default. Disabling them is accepting that unauthorized access can be granted
- Hospital network should be protected using a firewall and an up-to-date antivirus software tool.

2 COMPLIANCE WITH REGULATORY REQUIREMENTS

2.1 Compliance with Standards and Directives

OptoMonitor 3 complies with the applicable portions of the following standards:

CSA Standards:

CAN/CSA-C22.2 No. 60601-1:2014	CAN/CSA-C22.2 No. 60601-1:14: Medical Electrical Equipment - Part 1: General Requirements for Basic Safety and Essential Performance
CAN/CSA C22.2 No.60601-1-6:11 + AMD1	Medical Electrical Equipment – Part 1-6: General Requirements for basic safety and essential performance – Collateral Standards: Usability. (Adopted IEC 60601-1-6:2010, third edition, 2010-01 + A1:2013 – edition 3.1 This consolidated version consists of the third edition (2010) and its amendment 1 (2013-10)).
CAN/CSA C22.2 No.60601-2-34:12	Medical Electrical Equipment – Part 2-34: Particular requirements for the basic safety and essential performance of invasive blood pressure monitoring equipment.

ANSI/AAMI Standards:

ANSI/AAMI ES60601-1:2005/(R)2012, and C1:2009 and A2:2010(R)2012 (Consolidated text - edition 3.1)	Medical electrical equipment - Part 1: General requirements for basic safety and essential performance (IEC 60601-1:2005+A1:2012, MOD).
IEC60601-1-6 :2010 + A1 :2013	Medical Electrical Equipment – Part 1-6: General requirements for basic safety and essential performance – Collateral standard: Usability.
IEC60601-2-34 :2011	Medical Electrical Equipment – Part 2-34: Particular requirements for the basic safety and essential performance of invasive blood pressure monitoring equipment.
IEC60601-1-2:2007	Medical electrical equipment - Part 1: General requirements for basic safety and essential performance (third edition)
IEC60601-1-2:2014	Medical electrical equipment — Part 1-2: General requirements for basic safety and essential performance — Collateral Standard: Electromagnetic disturbances — Requirements and tests (fourth edition)

<u>ETSI Standards:</u>	
ETSI EN 301 489-17 V2.2.1	ElectroMagnetic Compatibility (EMC) standard for radio equipment and services; Part 17: Specific conditions for Broadband Data Transmission Systems; Harmonized Standard covering the essential requirements of article 3.1(b) of Directive 2014/53/EU
ETSI EN 300 328 V2.2.1	Wideband transmission systems; Data transmission equipment operating in the 2,4 GHz ISM band and using wide band modulation techniques; Harmonized Standard covering the essential requirements of article 3.2 of Directive 2014/53/EU

FCC standards (US Code of Federal Regulations, Title 47, Part 15 (47 CFR 15))

FCC 15.247	Systems Using Digital Modulation
RSS-247	Digital Transmission Systems (DTSs), Frequency Hopping Systems (FHSs) and License-Exempt Local Area Network (LE-LAN) Devices

Manufacturer's declaration - Electromagnetic emissions

The OptoMonitor 3 is intended for use in the electromagnetic environment specified below. The customer or the user of OptoMonitor 3 should ensure that it is in such an environment.

Emission test	Compliance level	Electromagnetic environment guidance
RF emissions CISPR 11	Group 1	The equipment uses RF energy only for its internal function. Therefore, its RF emissions are very low and are not likely to cause any interference in nearby electronic equipment.
RF emissions CISPR 11	Class A	
Harmonic emissions IEC 61000-3-2	Class A	The OptoMonitor 3 is suitable for use in all establishments other than domestic and those directly connected to the public low-voltage power supply network that supplies buildings used for domestic purposes.
Voltage fluctuations/flicker emissions IEC 61000-3-3	Complies	

Manufacturer's declaration - Electromagnetic immunity

The OptoMonitor 3 is intended for use in the electromagnetic environment specified below. The customer or the user of OptoMonitor 3 should ensure that it is in such an environment.

Immunity test	Basic standard or test method	EMC Compliance level	Electromagnetic environment guidance
Electrostatic discharge (ESD)	IEC 61000-4-2	± 2, 4, 6 kV contact	Floors should be wood, concrete, or ceramic tile. If floors are covered with synthetic material, the relative humidity should be at least 30%.
		± 2, 4, 8 kV air (IEC 60601-1-2 3 rd edition)	
Electrical fast transient/burst	IEC 61000-4-4	± 8 kV contact	Mains power quality should be that of a typical commercial or hospital environment
		± 2, 4, 8, 15 kV air (IEC 60601-1-2 4 th edition)	
Surge	IEC 61000-4-5	± 2 kV at 5 kHz power supply lines	Mains power quality should be that of a typical commercial or hospital environment
		± 1 kV at 5 kHz input/output lines (IEC 60601-1-2 3 rd edition)	
		± 2 kV at 100 kHz power supply lines	Mains power quality should be that of a typical commercial or hospital environment
		± 1 kV at 100 kHz input/output lines (IEC 60601-1-2 4 th edition)	
		± 0.5, 1kV with 0, 90, 270° differential mode	Mains power quality should be that of a typical commercial or hospital environment
		± 0.5, 1, 2 kV common mode with 0 or 180, 90, 270° (IEC 60601-1-2 3 rd edition)	
		± 0.5, 1 kV with 0, 90, 180, 270° differential mode	
		± 0.5, 1, 2 kV common mode (IEC 60601-1-2 4 th edition)	

Voltage dips, short interruptions, and voltage variations on power supply input lines	IEC 61000-4-11	5 % / 0.5 cycle	Mains power quality should be that of a typical commercial or hospital environment. If the user of OptoMonitor 3 requires continued operation during power mains interruptions, it is recommended that OptoMonitor 3 be powered from an uninterruptible power supply.
		40 % / 12 cycles	
		70 % / 30 cycles	
		0 and 180°	
		5 % / 5 s	
		(50 and 60 Hz)	
		(IEC 60601-1-2 3 rd edition)	
		0 % / 0.5 cycle	
		0 % / 1 cycle,	
		70 % / 30 cycles	
80 % / 300 cycles			
0 % / 300 cycles			
at 0, 45, 90, 135, 180, 225, 270, 315° for 50 and 60 Hz			
(IEC 60601-1-2 4 th edition)			
Power frequency magnetic field	IEC 61000-4-8	3 A/m 50 and 60 Hz	Power frequency magnetic fields should be at levels characteristic of a typical location in a typical commercial or hospital environment
		(IEC 60601-1-2 3 rd edition)	
		30 A/m 50 and 60 Hz	
		(IEC 60601-1-2 4 th edition)	

NOTE: UT is the A.C. mains voltage prior to application of the test level.

Manufacturer's declaration - Electromagnetic immunity

The OptoMonitor 3 is intended for use in the electromagnetic environment specified below. The customer or the user of OptoMonitor 3 should ensure that it is in such an environment.

Immunity test	Basic EMC standard or test method	Compliance level	Electromagnetic environment guidance
<i>Portable and mobile RF communication equipment should be used no closer to any part of OptoMonitor 3, including cables, than the recommended separation distance calculated from the equation applicable to the frequency of the transmitter.</i>			

Conducted RF	IEC 61000-4-6	3 Vrms - 0.15-80 MHz (IEC 60601-1-2 3 rd edition)	Recommended separation distance: d = 1,17V P
		3 Vrms - 0.15-80 MHz 6 Vrms in ISM bands, 80 %AM at 1 kHz (IEC 60601-1-2 4 th edition)	
Radiated RF	IEC 61000-4-3	3 V/m from 80 MHz to 2,5 GHz (IEC 60601-1-2 3 rd edition)	d = 1,17V P 80 MHz to 800 MHz d = 2,33VP 800 MHz to 2,5 GHz
		3 V/m from 80 MHz to 2,7 GHz (IEC 60601-1-2 4 th edition)	
		385 MHz z 27 V/m	
		450 MHz 28 V/m	
		710 MHz 9 V/m	
		745 MHz 9 V/m	
		780 MHz 9 V/m	
		810 MHz 28 V/m	
		870 MHz 28 V/m	
		930 MHz 28 V/m	
1720 MHz 28 V/m			
1845 MHz 28 V/m			
1970 MHz 28 V/m			
2450 MHz 28 V/m			
		(IEC 60601-1-2 4 th edition additional RF communication frequencies)	

Where P is the maximum output power rating of the transmitter in watts (W) according to the transmitter manufacturer and d is the recommended separation distance in meters (m).

Field strengths from fixed RF transmitters, as determined by an electromagnetic site survey (a), should be less than the compliance level in each frequency range (b).

Interference may occur in the vicinity of equipment marked with the following symbol:



Electro-surgery	IEC 60601-2-34	300 W cut mode 100 W coagulation mode	The OptoMonitor 3 essential performances are not affected by electro-surgery equipment due to the patient connection being optic.
-----------------	----------------	--	---

NOTE 1: At 80 MHz and 800 MHz, the higher frequency range applies.

NOTE 2: These guidelines may not apply in all situations. Electromagnetic propagation is affected by absorption and reflection from structures, objects, and people.

- (a) Field strengths from fixed transmitters, such as base stations for radio (cellular/cordless) telephones and land mobile radios, amateur radio, AM and FM radio broadcast and TV broadcast cannot be predicted theoretically with accuracy. To assess the electromagnetic environment due to fixed RF transmitters, an electromagnetic site survey should be considered. If the measured field strength in the location in which the OptoMonitor 3 is used exceeds the applicable RF compliance level above, the OptoMonitor 3 should be observed to verify normal operation. If abnormal performance is observed, additional measures may be necessary, such as re-orienting or relocating the OptoMonitor 3.
- (b) Over the frequency range 150 kHz to 80 MHz, field strengths should be less than 3 V/m.

Recommended separation distances between portable and mobile RF communications equipment and OptoMonitor 3			
The OptoMonitor 3 is intended for use in the electromagnetic environment in which radiated RF disturbances are controlled. The customer or the user of OptoMonitor 3 can help prevent electromagnetic interference by maintaining a minimum distance between portable and mobile RF communications equipment (transmitters) and OptoMonitor 3 as recommended below, according to the maximum output power of the communications equipment.			
Rated maximum output power of transmitter (W)	Separation distance to frequency of transmitter (m)		
	150 kHz to 80 MHz d = 1,17√ P	80 MHz to 800 MHz d = 1,17√ P	800 MHz to 2,5 GHz d = 2,33√ P
0,1	0,37	0,37	0,74
1	1,17	1,17	2,33
10	3,69	3,69	7,38
100	11,67	11,67	23,33

OptoWire™, SavvyWire™, Handle Unit and Aortic transducer are CF  and protected against the effects of a discharge of a defibrillator. Pressure readings may be affected during defibrillation.

2.2 RF Compliance

2.2.1 United States

This equipment has been tested and found to comply with the limits for a Class B digital device, pursuant to part 15 of the FCC Rules. These limits are designed to provide reasonable protection against harmful interference in a residential installation. This equipment generates, uses, and can radiate radio frequency energy, and if not installed and used in accordance with the instructions, may cause harmful interference to radio communications. However, there is no guarantee that interference will not occur in a particular installation. If this equipment does cause harmful interference to radio or television reception, which can be determined by turning the equipment off and on, the user is encouraged to try to correct the interference by one or more of the following measures:

- Reorient or relocate the receiving antenna.
- Increase the separation between the equipment and receiver.
- Connect the equipment into an outlet on a circuit different from that to which the receiver is connected.
- Consult the dealer or an experienced radio/TV technician for help.

2.2.2 Canada

This device complies with Industry Canada license exempt RSS standard(s). Operation is subject to the following two conditions: (1) this device may not cause interference, and (2) this device must accept any interference, including interference that may cause undesired operation of the device.

Le présent appareil est conforme aux CNR d'Industrie Canada applicables aux appareils radio exempts de licence. L'exploitation est autorisée aux deux conditions suivantes: (1) l'appareil ne doit pas produire de brouillage, et (2) l'utilisateur de l'appareil doit accepter tout brouillage radioélectrique subi, même si le brouillage est susceptible d'en compromettre le fonctionnement.

2.2.3 Japan

当該機器には電波法に基づく、技術基準適合証明等を受けた特定無線設備を装着している。

This equipment contains specified radio equipment that has been certified to the Technical Regulation Conformity Certification under the Radio Law.

2.3 Essential performance

Below is the list of essential performance of the OptoMonitor 3 and what degradation an operator can expect if the essential performance is lost or degraded due to electromagnetic disturbance.

Essential performance	Degradation observed
Electrical isolation for DC/DC converters in interfaces for Aux, Pa inputs and output, Pd output and HU interface	Noise or loss of functionality appearing during a patient defibrillation.
Risk of fire or loss of isolation induced by component failure and mitigated by fail-safe functionalities	Unit doesn't turn on, error on display unit or all LED on OpM3 or flashing when turned on.
Protection against defibrillation	Noise or loss of functionality appearing during a patient defibrillation.
Accuracy of pressure measurements	Noise on signal that are disturbing the average, loss of signal, loss of connection HU device.

2.4 Deviation from the standards

There were no deviations from the applicable portions of the standards listed above during OptoMonitor 3 system compliance assessment

3 OVERVIEW OF THE OPTOMONITOR 3 SYSTEM

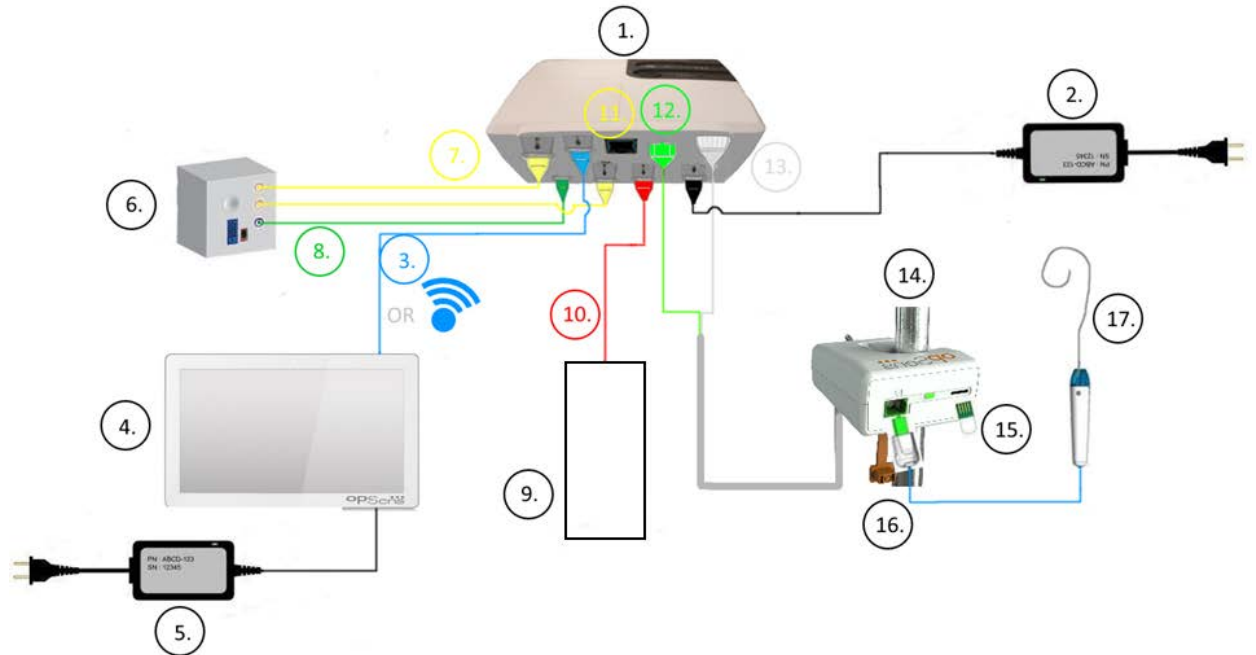

Item	Description	Item	Description
1	OptoMonitor 3 Optical Unit (OpM3-OU)	10	Aortic Transducer Interface Cable (Aortic In)
2	OpM3-OU Power cord & External Power Supply	11	Pressure Output Interface Cable (Aortic Out)
3	OU-DU Communication Cable (Or Wireless Communication, depending on Setup)	12	HU Optical Connector
4	OptoMonitor 3 Display Unit (OpM3-DU) Two accessible output: USB connector for port powered USB key only (not supplied), video output for external monitor (not supplied).	13	HU Electrical Connector
5	OpM3-DU Power Cord & External Power Supply	14	OptoMonitor 3 Handle Unit (OpM3-HU)
6	Cathlab Hemodynamic System (Supplied by others)	15	Gauge Factor Connector (GFC) (Where Applicable)
7	Pressure Output Interface Cable (Distal Out)	16	OpSens wire Cable with FOIC Connector
8	AUX Interface Cable (AUX In)	17	OpSens pressure guidewire
9	Aortic Transducer (Supplied by others)		

3.1 OptoMonitor 3 Optical Unit (OpM3-OU)



The Optical unit computes the pressure obtained from OpSens' pressure guidewires: OptoWire™ and SavvyWire™. It is the main unit that provides connections to the Cathlab Hemodynamic System, Aortic Transducer, Display Unit, and the Handle Unit. The Optical Unit has 6 LED's on its front face that alerts the user in various ways (see section 3.6.2).

The OptoMonitor 3 Optical Unit (OpM3-OU) includes the following cables:

- 1) 12 V Power supply and cable
- 2) AC cable cord of specific country
- 3) Communication cable with the DU (COM if 10", LAN if 15")

Depending on intended Cathlab-OptoMonitor 3 connection, the OU **may** also include any of the following cables:

- 1) Interface cable for Pa input (from the hemodynamic system or Aortic Transducer)
- 2) Interface cable for ECG input (from the hemodynamic system)
- 3) Interface cable for Pd output to the hemodynamic system
- 4) Interface cable for Pa output to the hemodynamic system

The OptoMonitor 3 is supplied with a power supply cord having three conductors; the earth conductor is only a functional earth.

The OptoMonitor 3 Optical Unit supports both wired and wireless connection to its Display Unit. The wired connection is through an OU-DU communication cable if using the smaller 10" DU, or through a LAN wire if using the larger 15" DU.

The Optical Unit has 9 ports through its bottom face. They consist of:

- One DC power plug
- Two Handle Unit connections (one for electrical connection, one for optical connection)
- One LAN port
- One COM port

- Four pressure input/output interface cable ports (see 3.2)

3.2 Cathlab Interface Cables

OpSens can provide interface cables connecting the OptoMonitor 3 systems to the Cathlab Hemodynamic System. These cables are customized to the specific types of monitoring equipment in your Cathlab.

3.2.1 AUX In (AUX Interface Cable)

Mandatory unless using Ao Transducer Interface cable (3.2.2). Provides Optical Unit with Pa readings from the Cathlab Hemodynamic System. If the Aortic Transducer cable is used, this cable can be used to provide an ECG signal to the Optical Unit. Cable model depends on your current Cathlab Hemodynamic System.

3.2.2 Aortic In (Ao Transducer Interface Cable)

Mandatory unless using Aux Interface cable (3.2.1). Provides Optical Unit with Pa readings directly from the Aortic Transducer, making the OptoMonitor 3 a more independent device. Cable model depends on your current Aortic Transducer system.

3.2.3 Aortic Out Cable (Pressure Output Interface Cable)

Mandatory if using the Ao Transducer Interface cable (3.2.2), otherwise optional. Sends Pa readings to your Cathlab Hemodynamic System. Cable model depends on your current Cathlab Hemodynamic System.

3.2.4 Distal Out (Pressure Output Interface Cable)

Optional. Sends Pd readings obtained from the pressure guidewire to the hemodynamic system in the Cathlab. Cable model depends on your current Cathlab Hemodynamic System.

3.3 OptoMonitor 3 Display Unit (OpM3-DU)

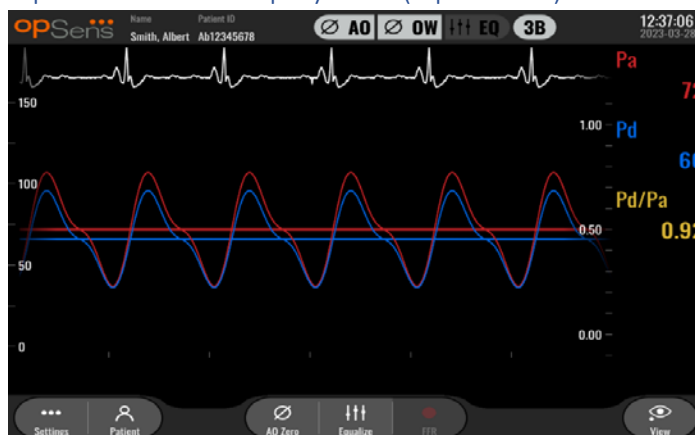

3.3.1 Overview of the DU

The OptoMonitor 3 Display Unit is the OptoMonitor 3 user interface. It displays the system status, performs pressure averaging, calculates measurements, and displays relevant graphical curves and data. The DU also has built in speakers that alert the user in various ways (see section 3.6.1).

The Display Unit (OpM3-DU) includes the following items:

- 1) OU-DU communication cable (COM if using 10" DU, LAN if using 15" DU)
- 2) Plug-in extensions (number varies based on options).

OpSens has made the OpM3-DU available to all customers in two different sizes: small (10") and large (15").

The only difference between the two units is their size and availability of ports. All functions, explanations, and any other statement regarding the OpM3-DU applies to both sizes of DU; the systems operate identically.

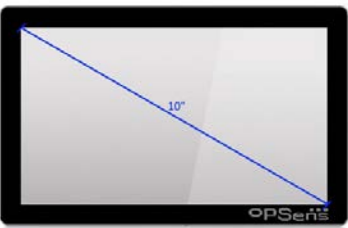
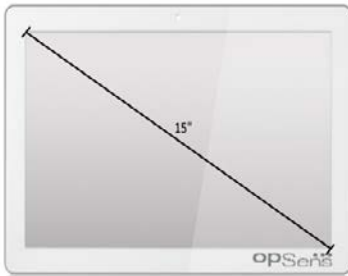
	DU-10"	DU-15"
Picture		
Screen Size	10 inches	15 inches
Power Port	One	One
LAN Port	One	Two
USB driver ports (for USB key only)	One	One
COM port	One	None
External Monitoring	VGA port	DVI-D or HDMI port (depending on model)
Advantages	Its smaller size makes it lightweight and highly portable. It is the ideal choice for the customer who wishes to use this device mounted on the bedside.	Its increased screen size makes data and functions very clear, and the increased number of ports on the device makes it far more versatile. It is ideal for control room operation.

3.4 OptoMonitor 3 Handle Unit (OpM3-HU)



The OptoMonitor 3 Handle Unit provides the link between the OpSens pressure guidewire and the Optical Unit. The Handle Unit also has a LED on its front face that alerts the user in various ways (see section 3.6.2).

The Handle Unit has a square green port on its front face, which is meant for wire connection, as well as a smaller slot connection for the gauge factor connector (where applicable).

NOTE: The Handle Unit must be placed outside the sterile field.

3.5 Accessories

3.5.1 OptoWire™ Pressure Guidewire (not supplied)

The OpSens OptoWire™ Pressure Guidewire provides the distal pressure required to calculate both the dPR and FFR. This accessory is a single use.

Please contact your representative for OptoWire™ purchase.

Please refer to OptoWire™ IFU for the following:

- Disposal of unit after use
- As applicable, the appropriate process for cleaning and packaging
- Sterilization method
- Necessary instructions in the event of damage to sterile packaging
- Precautions to be taken in the event of changes to the performance of the OW as a result of ageing and environmental conditions.

3.5.2 SavvyWire™ Pressure Guidewire (not supplied)

The OpSens SavvyWire™ Pressure guidewire provides the left ventricular (LV) pressure during structural heart procedures. This accessory is a single use.

Please contact your representative for the purchase.

Please refer to the SavvyWire™ pressure guidewire IFU for the following:

- Disposal of unit after use
- As applicable, the appropriate process for cleaning and packaging
- Sterilization method
- Necessary instructions in the event of damage to sterile packaging
- Precautions to be taken in the event of changes to the performance of the SavvyWire as a result of ageing and environmental conditions.

3.5.3 Aortic transducer (supplied by others)

The Optical Unit uses the signals from OptoWire™ and an Aortic Pressure input to calculate FFR, dPR and TAVI measurements.

The aortic pressure reading can be obtained either from a Cathlab Hemodynamic System, via AUX input, or an aortic transducer, via Aortic Transducer Input. If using a direct connection to the Aortic Transducer, the transducer shall meet the following requirements:

ANSI/AAMI BP22 compliant transducer with the following specifications:

- 1) Sensitivity: 5 μ V/V/mmHg
- 2) Excitation voltage: 4 to 8 Vrms
- 3) Excitation impedance: > 200 ohms
- 4) Signal Impedance: < 3000 ohms.
- 5) Minimum pressure range -30 to 300 mmHg

Refer to the instructions for use provided by the Aortic Pressure Transducer manufacturer for the following:

- Disposal of unit after use
- Restrictions on number of reuses.
- As applicable, the appropriate process for cleaning and packaging
- Sterilization method
- Necessary instructions in the event of damage to sterile packaging
- Precautions to be taken in the event of changes to the performance of the transducer as a result of ageing and environmental conditions.

3.6 Audio and LED Indicators

The OptoMonitor 3 has LEDs and audio indicators to identify the system status and performances.

The audio indicators are expressed in low, medium, and high pitch tones.

3.6.1 Audio Indicators

Events	Audio	Descriptions
Optical connection event	2 Low tones	Optical disconnection occurred

Optical connection event	2 High tones	Optical connection occurred
Zeroing function	3 Tones L-M-H*	Zero completed
Zeroing function	3 Medium tones	Pressure guidewire Zero failed, aborted
Equalization function	1 Low tone	Equalization reset
Device matching indication	3 Medium tones	GF connector and OptoWire™ mismatch
Data communication	4 High tones	Data communication lost between Display Unit and Optical Unit

*L-M-H: Low – Medium – High



3.6.2 Color Indicators



The LED indicator on the OptoMonitor 3 system will help you monitor the status of the system performances.

3.6.2.1 Optical Unit and Display Unit Indicators:

The Optical Unit has six LED indicators on its front face, split into a top row of four LED's and a bottom row of two LED's.



1. The first LED  of the bottom row indicates Optical Unit power status. A steady **Blue** indicator indicates that the Optical Unit is powered.
2. The second LED  of the bottom row indicates Optical Unit wireless connection with the Display Unit. Indicator is OFF when OU wireless function is not activated. A flashing **Blue** indicator indicates that OU wireless is activated but not currently connected with a DU unit. A steady **Blue** indicator indicates that the OU and DU are wirelessly connected.
3. The first LED  of the top row indicates status of electrical connection with the Handle Unit. A steady **Green** indicator indicates that the electrical connection between the OU and HU is stable.

4. The second LED  of the top row indicates status of the optical connection with the Handle Unit. A steady **Green** indicator indicates that the optical connection between the OU and HU is stable.
5. The third LED  of the top row indicates OpSens pressure wire zeroing status. A steady **Green** indicator indicates that the pressure wire has successfully been zeroed to atmospheric pressure.
6. The fourth LED  of the top row indicates equalization status between the pressure wire and aortic pressure. A steady **Green** indicator indicates that the pressure wire and the aortic pressure have successfully been equalized to the same pressure.

The power supply to the Display Unit has one LED, which will have a steady **Green** to indicate that the DU is powered **ON**.





3.6.2.2 General system status

OU power: Flashing blue	System not ready to use. Refer to messages in the Display Unit's Message window.
OU top row LEDs: Third flashing, fourth solid	The OU is updating. Refer to section 8.9 to update OU.
OU top row LEDs: All flashing	System is in error. Restart the OU. If the LEDs are still flashing after restarting the OU, please contact OpSens or personnel authorized by OpSens.





3.6.2.3 Handle Unit Indicators:

The Handle Unit green and amber LED indicators provide information using color and flash-coded sequences. Please refer to table below for more details.

The flash-coded sequences are represented graphically on the Handle unit as follow:

Fast pulsing	
Slow pulsing (every 2 – 3 seconds)	
Slow flashing	
Steady on	

Events	Led indicators	Message on Display Unit
GFC connector not inserted to Handle Unit – Insert GFC		Connect GF connector to Handle Unit

Optical connection loss – Connect/Check OW		No signal, check OptoWire connection No signal, check SavvyWire connection
System ready/Zero completed		
Wire Zero failed/Aborted		OptoWire zero aborted (signal unstable) OptoWire zero aborted (signal unstable), old value used SavvyWire zero aborted (signal unstable)
GFC & OW mismatch		Mismatch between OptoWire and GF connector

NOTE: Amber LED indications usually mean the system requires operator attention.

3.7 Graphical User Interface

OptoMonitor 3 Interface comprises a touch screen display with a graphical user interface through which all user interaction is performed. Measurements are displayed as real-time graphical curves as well as numerical values. The graphical layout may change depending on selected measurement mode, or current state of the instrument.

INFORMATION SCREEN

At start-up of the device, the application access code must be entered to access the MAIN screen.

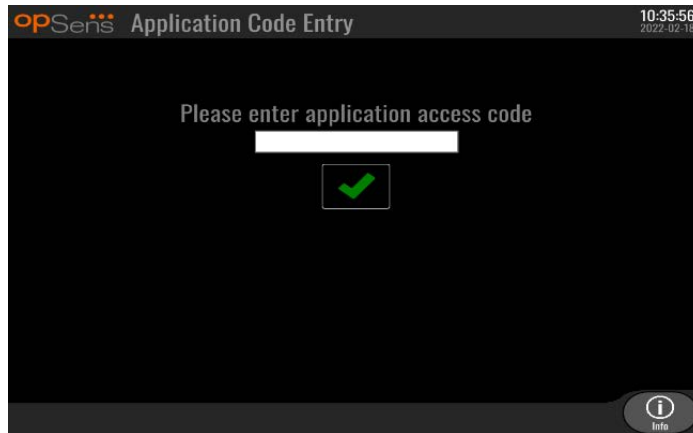

Before accessing the Main Screen, it is possible to access the System Info Screen through the Information Button.

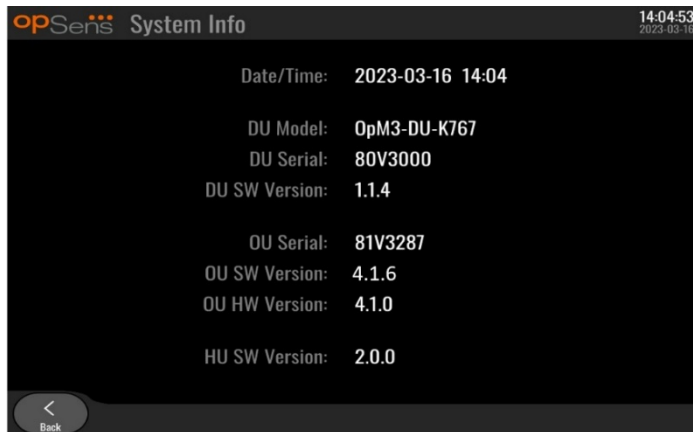

This page displays all information about the OpM3: The date and time set by the DU, the DU module number, the DU and OU serial number, as well as the OU, DU and HU installed software versions and the OU hardware version.

MAIN SCREEN

The first screen that appears when the instrument has been started is the MAIN screen. The MAIN screen is divided into five areas as shown below.

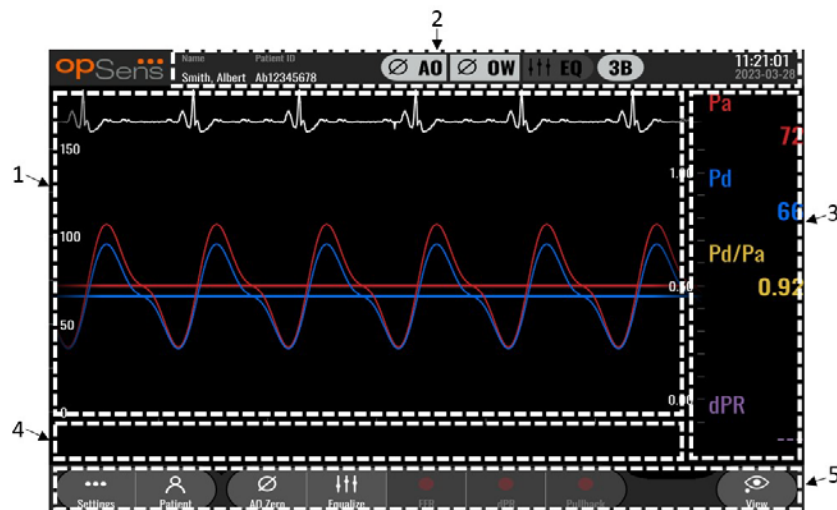

1. Graphic window:

Real time and averaged pressures or ratios. This window changes based on functions and modes.

2. Information field:

Status indicators, averaging period, patient name, patient ID, date, and time.

3. Data window:

Numeric values such as pressures, pulse rate, gradients, and indices. In Playback, the values shown are related to a cursor or selected part of the signal. Some values are clickable and will impact values and/or signal shown.

4. Message window:

Information and warning messages. Once recording has started, the elapsed time (hh:mm:ss) is displayed at the top left of the message windows.

5. Menu window:

Submenu's and function buttons.

When the transducer input is selected as the aortic signal, the auxiliary input can be connected to the Cathlab Hemodynamic system to receive an ECG signal. Enabling the "Show ECG" setting will show the received signal in live and playback. It is displayed above the pressure curves.

3.8 Coronary procedure main Menu Screen Functions

Navigation through the instrument's software menus is easily done in one single step using the direct access buttons on the bottom of the touchscreen (menu window).

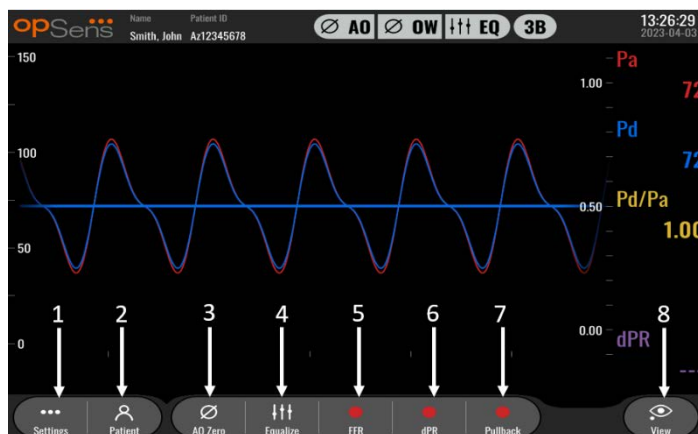

1. Settings button

Pressing this button switches the screen to the SETTINGS screen.

2. Patient button

Access the patient information dialogue to enter patient name, ID, gender, date of birth, procedure date, accession number, performing physician name, and study description. From the patient information dialogue, you can access the DICOM list. See section 7.10.1 for more information.

NOTE: It is required to create the patient ID before each case to associate recordings to a specific patient.

3. Ao Zero button

OptoMonitor 3 Aortic Zero. See section 7.2.2 for more information.

4. Equalization button

Equalize OptoWire (Pd) pressure to Aortic (Pa) pressure. See section 7.5 for more information.

5. FFR button

Begin recording a mean Pd/mean Pa measurement. When pressed, it changes to a STOP FFR button, pressing which will end the recording and switch the screen to playback mode (3.10). Pressing FFR button also automatically starts the minimum mean Pd/Pa tracking. The number of beats the FFR calculation averages over (default = 3) is set by the user in the SETTINGS screen. See section 7.6 for more information on FFR.

6. dPR button

Begin recording and calculation of the diastolic pressure ratio. Display will automatically switch to playback mode (3.10) upon completion. See section 7.7.1 for more information.

7. dPR Pullback button

Begin a dPR pullback measurement. When pressed, it changes to a STOP Pullback button, pressing which will end measurement and switch the screen to playback mode (3.10). See section 7.7.2 for more information.

8. View button

Press this button to watch previously recorded measurements. Pressing this button switches the screen to playback mode (3.10). If patient data has been entered, all previous recordings saved under this patient ID will appear in the message window in the playback screen.

3.9 Structural procedure main Menu Screen Functions

Navigation through the instrument's software menus is easily done in one single step using the direct access buttons on the bottom of the touchscreen (menu window).

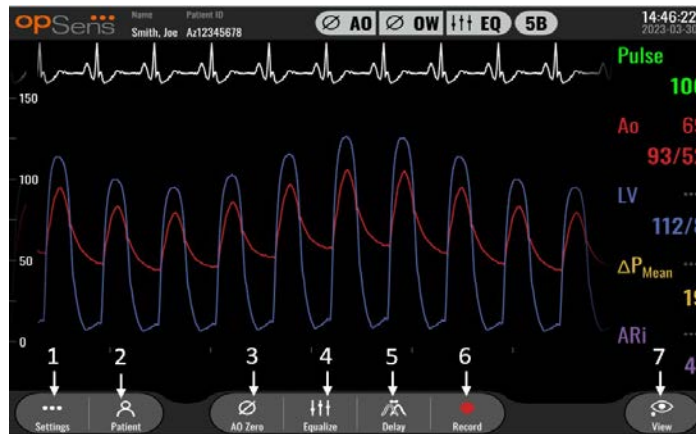

1. Settings button

Pressing this button switches the screen to the SETTINGS (section 0) screen.

2. Patient button

Access the patient information dialogue to enter patient name, ID, gender, date of birth, procedure date, accession number, performing physician name, and study description. From the patient information dialogue, you can access the DICOM list. See section 7.10.1 for more information.

NOTE: It is required to create the patient ID before each case to associate recordings to a specific patient.

3. Ao Zero button

OptoMonitor 3 Aortic Zero. See section 7.2.2 for more information.

4. Equalization button

Equalize OpSens pressure wire (LV) pressure to Aortic (Ao) pressure. See section 7.5 for more information.

5. Delay

Press once for automatic adjustment.

Press a second time for the delay adjustment menu and manual delay adjustment.



6. Record button

Begin recording the pressures and measurements. When pressed, it changes to a STOP button, pressing which will end the recording and switch the screen to playback mode (3.10). The number of beats the calculations averages over (default=5) is set by the user in the SETTINGS screen (section 0). See section 7.6 for more information. The pulse rate measurement is always measured on an average of 10 beats.

7. View button

Press this button to watch previously recorded measurements. Pressing this button switches the screen to playback mode (3.10). If patient data has been entered, all previous recordings saved under this patient ID will appear in the message window in the playback screen.

3.10 Playback Mode Functions

In the playback screen, the message window is replaced by a recording's navigator consisting of a selection box that can be used to select the desired recording to display and left and right arrows to navigate through the recordings in chronological order. A smaller graphic window is also displayed to present the user an overview of the current recording and move through the recording when a zoom is in effect. In this screen, the user can use its fingers inside the main graphic window to manage the zoom by pinching and move through the recording by dragging. Selecting a recording will cause the screen to show the recorded pressure measurements, update the small graphic window containing the full-length recorded measurements, and the total time of recording. The screen will also update the graphic window and the data window, depending on the type of recording it is:

- An FFR recording will display the recorded measurements in the graphic window, as well as the minimum FFR over the recording in the data window. A yellow line will be placed at the point of minimum FFR. The user can scroll through the recorded measurements to see changes of Pa and Pd over time. Pressing the FFR button in the data window will return the marker to the point of minimum FFR.

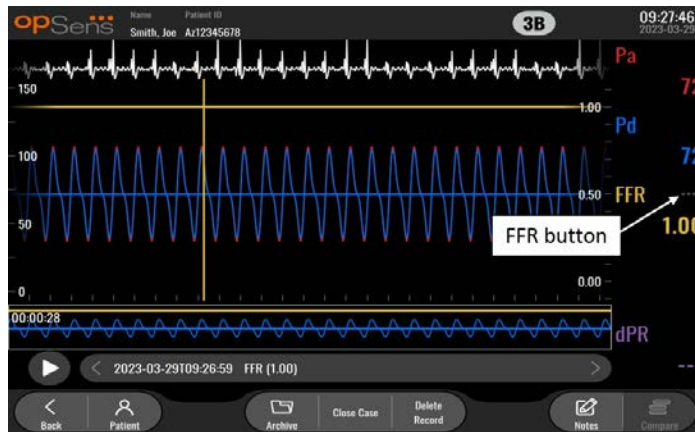

- A dPR recording will display the dPR value over the length of the recording. No values for Pa, Pd, or Pd/Pa will be displayed in this playback mode.



- A dPR pullback recording will display the recorded measurements and the dPR pullback value over time in the graphical window. Minimum dPR over the pullback will display in the data window, as well as be marked by a purple line at the point of minimum dPR in the graphical window. No values for Pa, Pd, or Pd/Pa will be displayed in this playback mode. Pressing the dPR button in the data window will return the marker to the point of minimum dPR.

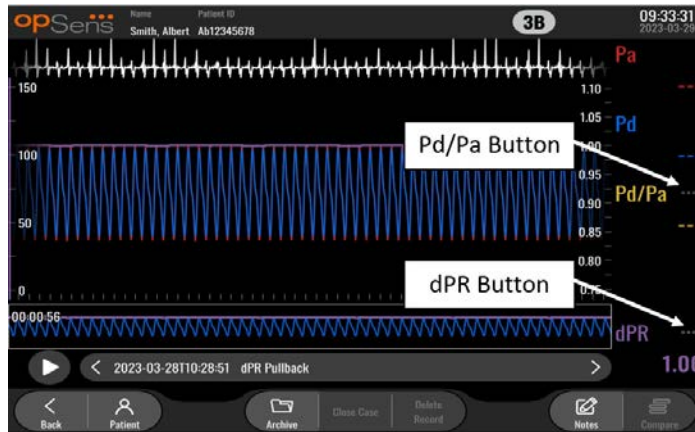

- Pressing the Pd/Pa button in the information window while in a dPR pullback playback will cause the playback to switch to “Pd/Pa” mode, where the graphical window will be updated with Pd/Pa over time and be marked by a yellow line at the point of minimum Pd/Pa, as well as update the data window accordingly. Pressing the Pd/Pa button in the data window will return the marker to the point of minimum Pd/Pa.

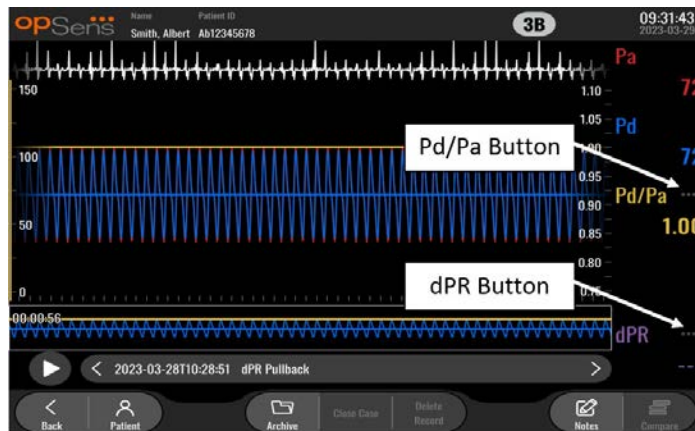

- Pressing the dPR button in the data window will resume the display of dPR value and dPR pullback pressure curves.



- A TAVI recording will display the recorded measurements in the graphical window. The beats used to calculate measurements are selectable by a click on the data. Measurements, gradients, and indices are displayed in the data window. The 3 dots next to the measurements indicate the possibility to click on the data and change the shown measurement.

3.10.1 Universal Menu Functions

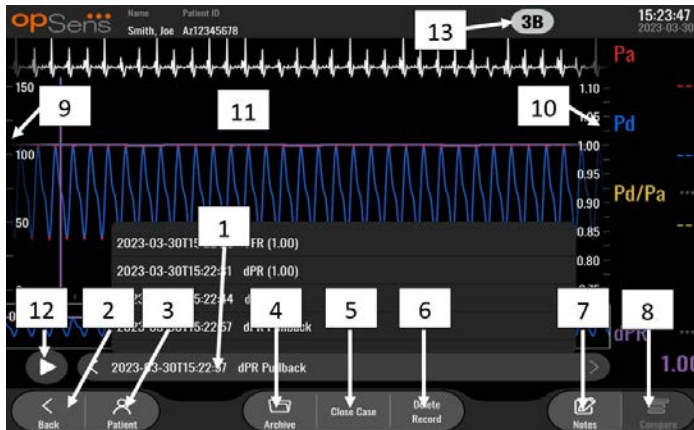

1. Recordings selection box

This selection box allows choosing among all recordings of a current patient case. If no case is open (see section 6), all previous recordings made without an open case will appear in this window (with the “NoPatient” ID). Tapping this box then a specific recording will cause its recorded measurements to update the graphical window and data window accordingly. The recordings can also be browsed in the order they were recorded with the left and right arrow buttons.

2. Back button

Press this button to return to the MAIN screen.

3. Patient button

Access the patient information dialogue to view patient name, ID, gender, date of birth, procedure date, accession number, performing physician, and study description. See section 7.10.1 for more information.

4. Archive button

Press this button to view previous recordings. Accessing previous recordings will close the current case, if open. This menu should therefore not be accessed while a case is ongoing.

5. Close Case button

Press this button to close the current Patient case. All recordings for the current patient will be stored in Archive, and patient information will be set back to default.

6. Delete Record button

Press this button to delete the recording that is currently selected in the recording selection box.

7. Notes button

Press this button to access information linked to the recording. For an FFR/dPR/dPR pullback recording, the user can note the vessel of procedural interest, which will update a visual map of the vascular system. The user can also note the physiological assessment of the patient, note the procedural step, and note the drug used. See section 7.10.2 and 7.10.3 for more information.

8. Compare button

Press this button to go to the compare screen ([7.9.5](#)). Available only for TAVI.

9. Pressure scale

Press the pressure scale to manually change the selected scale.

10. dPR scale

Press the dPR scale while in viewing a dPR Pullback in playback mode to manually change the selected scale.

11. Zoom in / Zoom out function

To reduce the total segment in view (zoom in), using 2 fingers in the graphical area and move them apart (pinch out). To increase the total segment in view (zoom out), using 2 fingers in the graphical area and move them closer together (pinch in).

The zoom out is possible until the entire length of the recorded graph is in view.

12. Play button

Press this button to see a playback of the selected recording. When pressed, it changes to a STOP button, pressing which will end the playback and return to the playback screen. As the system plays the recording, the time of the playback will be displayed to the left of the full recording window.

13. Averaging period

This indicates the averaging period. The averaging period indicates the number of heart beats over which the following values are averaged:

- Pa average: applies to FFR, dPR and dPR pullback recordings
- Pd average: applies to FFR, dPR and dPR pullback recordings
- FFR: applies to FFR recordings
- Pd/Pa: applies to dPR and dPR pullback recordings
- Ao and LV systolic and diastolic values: applies to TAVI recordings

It can be edited in the settings between 1, 2, 3, 4, or 5 beats.

In a TAVI recording, it is possible to press the number-of-beats icon and the Select indices period window will pop-up as follows:

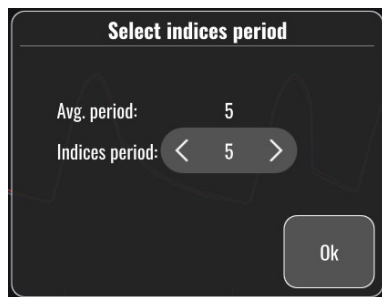

Changing the indices period will change the number of selectable beats in playback. This affects only the current recording, and the affected measurements are: LVEDP, gradients and regurgitation indices.

3.10.2 Archive Menu Functions

The archive screen displays the patient folder table. This table is filled with all the recordings stored on the DU. The list is initially sorted by procedure date but can be sorted by pressing a column title. The Status Column indicated whether the recording has already been exported or not:

N/A: Not applicable status (used for folders that have no patient associated)

--- : The patient folder has never been exported or it has been exported but at least one of the recording from the patient folder has been added, removed, or updated since.

USB: The patient folder has only been USB exported (or Anonymously exported).

PACS: The patient folder has only been DICOM exported.

U+P: The patient folder has been USB exported (or Anonymously exported) and has also been DICOM exported.

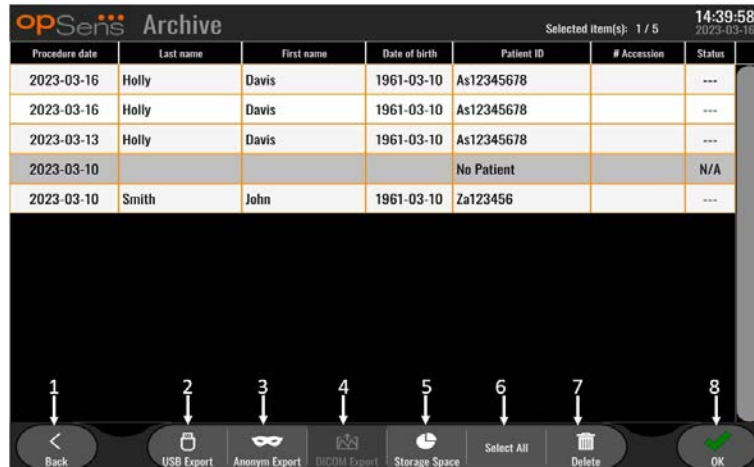

1. Back button

Press this button to exit the Archive View without changing the viewed case.

2. USB Export button

Press this button to export recording to an external hardware device (USB drive).

3. Anonymous Export button

Press this button to perform the same action as USB Export button anonymously. This button will upload the recordings without patient information.

4. DICOM Export button

If the system is properly configured to be connected to the hospital's network, it is possible to export the procedures graphical and numerical data via DICOM. Press this button to send a screen capture and data of the case recordings to the PACS.

5. Storage Space button

Press this button to display the "Storage Space" pop-up window. This pop-up window will display information about internal storage and external hardware device storage (USB storage).

6. Select All button

Press this button to select or deselect all cases in the Archive Window.

7. Delete button

Press this button to delete the selected cases.

8. Check mark button

Press this button to open selected case. If no case is selected, the latest case will remain in the view window.

4 OPTOMONITOR 3 INSTALLATION

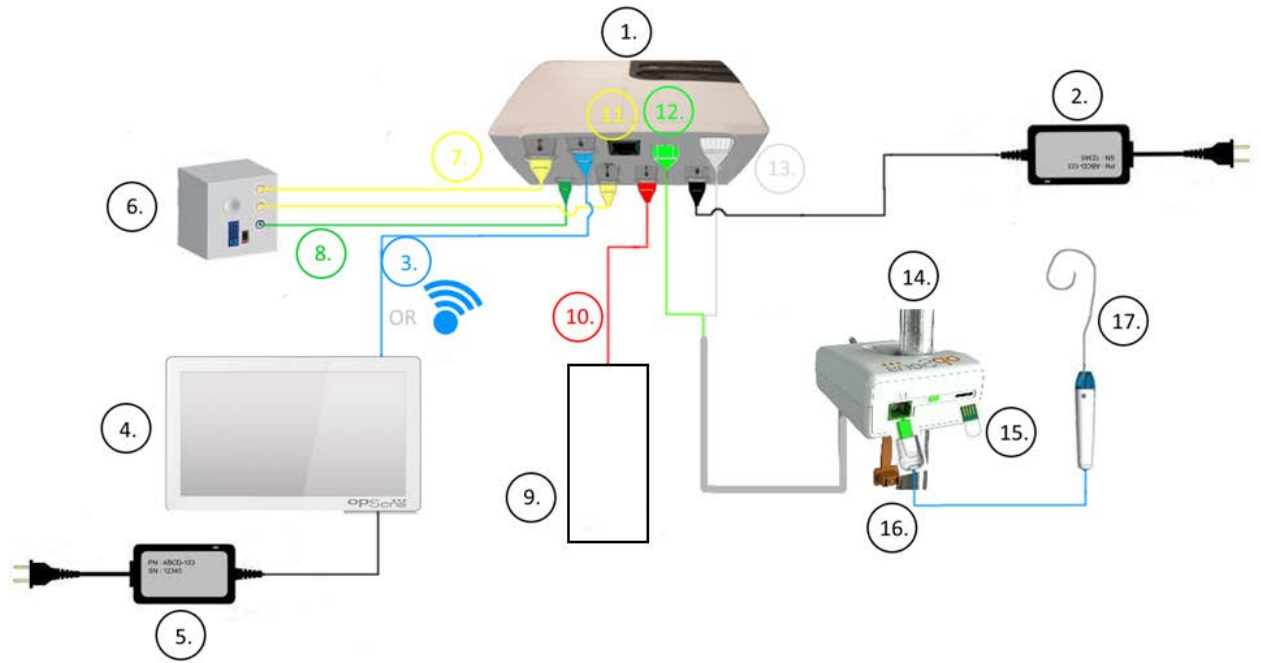

Item	Description	Item	Description
1	OptoMonitor 3 Optical Unit (OpM3-OU)	10	Aortic Transducer Interface Cable (Aortic In)
2	OpM3-OU Power cord & External Power Supply	11	Pressure Output Interface Cable (Aortic Out)
3	OU-DU Communication Cable (Or Wireless Communication, Depending on Setup)	12	HU Optical Connector
4	OptoMonitor 3 Display Unit (OpM3-DU)	13	HU Electrical Connector
5	OpM3-DU Power Cord & External Power Supply	14	OptoMonitor 3 Handle Unit (OpM3-HU)
6	Cathlab Hemodynamic System (Supplied by others)	15	Gauge Factor Connector (Where Applicable)

7	Pressure Output Interface Cable (Distal Out)	16	OpSens wire Cable with FOIC Connector
8	AUX Interface Cable (AUX In)	17	OpSens pressure guidewire
9	Aortic Transducer (Supplied by others)		

4.1 Unpacking the OptoMonitor 3 System

Unpack the box and check that the following components have been supplied:

- One Optical Unit with OU power supply and main cable
- One Handle Unit
- One Display Unit with DU power supply, OU-DU communication cable, mounting clamp and screws.

Depending on intended Cathlab-OptoMonitor 3 connection, the box **may** also include any of the following cables:

- Interface cable for Pa input (from the hemodynamic system or Aortic Transducer)
- Interface cable for Pd output to the hemodynamic system
- Interface cable for Pa output to the hemodynamic system
- One DICOM cable – optional

NOTE: Before use, always check that all parts are present and undamaged.

4.2 Mounting the devices

4.2.1 Mounting the devices

There are several possibilities for mounting the different parts of the OpM3. Please refer to part **15 Appendix A: OptoMonitor 3 Installation Instructions** for further installation instructions.

4.2.2 Mounting the Optical Unit

The Optical Unit is suitable for installation within patient environment. Install OptoMonitor 3 Optical Unit securely under the bed or other nearby location. Ensure the Optical Unit and Display Unit are close enough to connect the OU-DU communication cable, or if using wireless connection, ensure there is no interference that would interrupt the signal between the OU and DU.

NOTE: If replacing a OptoMonitor, ensure power supply is replaced as well. OptoMonitor power supply is not authorized for use with the OpM3.

4.2.3 Mounting the Display Unit

The Display Unit is suitable for installation within patient environment. If using the hardwired connection between OU and DU, follow these steps to mount the OptoMonitor 3 Display Unit bedside:

1. Attach the clamp and adapter plate to the rear of the OptoMonitor 3 Display Unit with the supplied screws.
2. Affix OptoMonitor 3 Display Unit to a suitable place on an IV pole (not shown). Ensure that the mounting of OptoMonitor 3 Display Unit is secured and that its position is stable.
3. Connect the OU-DU communication cable (Blue COM wire to COM1 in DU-10", LAN cable to LAN2 in DU-15").

It is also possible to use a third-party screen support if needed. The DU-10" and the DU-15" can both be attached to a VESA screen support. The DU-10" can be attached to a 75x75 VESA support and the DU-15" can be attached to a 10x10 VESA support.

If using the wireless connection between OU and DU, install the DU in a location which is accessible and safe to use, and can maintain consistent wireless connection with the OU. This includes any acceptable location within the control room. Wireless dongle can be connected in any free USB port but should not be connected using an extension cable.

To activate the Wireless feature on the OU (wireless LED flashing), it is required to connect the OU and DU using a wired connection and then toggle the wireless setting off then back on in the DU Networks parameters screen. Once wireless is turned on, the communication cable can be removed.

When using wireless communication between the OU and DU, factors such as distance and disturbances from nearby equipment can impact quality of signal. In such cases, a message will appear on screen to indicate information loss. Communication link will be reset if data loss is recurring. To correct this situation, relocating the OU and DU to reduce the distance (approximately 10 m line-of-sight) and/or proximity to other equipment may help. If problem persists, a wired connection may be required.

4.3 Connecting the Handle Unit

The Handle Unit is suitable for installation within patient environment. The Handle Unit is the connection cable between the pressure guidewire and the Optical Unit.

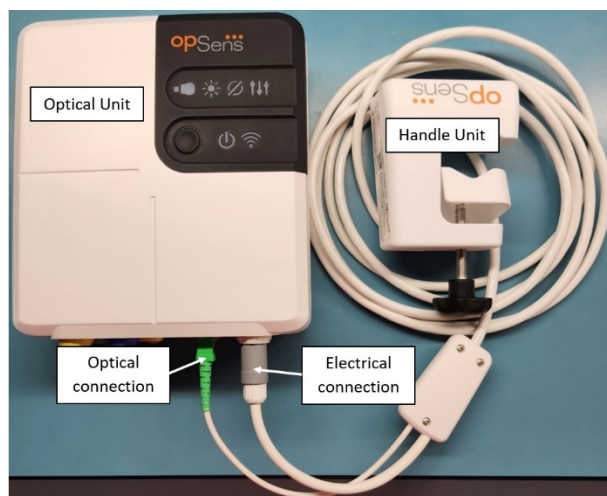

1. Handle Unit connects to the Optical Unit. Ensure secure connection of both the electrical connection (white) and square optical connection (green).
2. The pressure Guidewire connects to the square optical connector of the Handle Unit.

CAUTIONS:

- The Handle Unit must be placed outside of the sterile field.
- To keep optical connector clean, it is always recommended to keep the Handle Unit connected to the Optical Unit. Disconnect only when the unit needs replacing.
- Avoid dropping the Handle Unit as it may cause damage to the device. Do not use the device if it appears damaged or deformed.
- Always reinstall the dust cap protector(s) on the optical connector(s). Dust entering the connector(s) may reduce the optical signal quality and generate “No optical signal” warning messages.

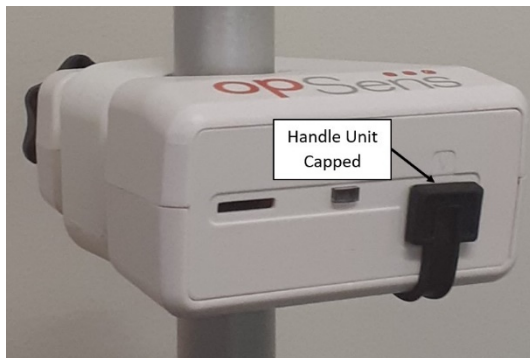

4.4 Connecting to Mains Supply

- Connect the power supply cable to the Optical Unit and secure the plug with the threaded ring.
- Connect the mains cable from the power supply attached to the Optical Unit into a suitable power outlet.
- Repeat the same process to connect the Display Unit to the main supply. Both OU and DU will automatically turn on once it is powered. Note that the same logic will apply during power losses.

WARNING:

- Use only power supplies and power cords provided by OpSens.

4.5 Connecting to Cathlab Hemodynamic High-Level Aortic Output

The Optical Unit uses the signals from OpSens’ pressure guidewire and Aortic Pressure input to calculate both the dPR and FFR.

The Optical Unit must be connected to a Cathlab Hemodynamic System or Aortic Transducer in order to access to the aortic pressure (Pa). If using the Cathlab Hemodynamic System:

- 1- Connect the AUX interface cable (green) to the hemodynamic high-level pressure output associated to the Aortic pressure.
- 2- Connect the AUX interface cable to the green connector of the Optical Unit (labelled AUX In).

NOTE: This is the high level (100 mmHg/V) input for aortic pressure from a Cathlab Hemodynamic System. Aortic blood pressure measurements are required for the dPR and FFR calculations.

4.6 Connecting to Aortic Transducer (Aortic Input)

The Optical Unit uses the signals from OpSens' pressure guidewire and Aortic Pressure input to calculate both the dPR and FFR.

The Optical Unit must be connected to a Cathlab Hemodynamic System or Aortic Transducer to access the aortic pressure (Pa). If using a direct connection to the Aortic Transducer:

- 1- Connect the Ao transducer interface cable (red) to the Aortic Transducer output associated to the Aortic pressure.
- 2- Connect the Ao transducer interface cable to the red connector of the Optical Unit (labelled Aortic Transducer).
- 3- From the Main Screen on the DU, navigate to Settings > Maintenance > Input/Output Calibration > Pa Source and select Transducer.

4.7 Connecting Aortic Output to Cathlab Hemodynamic- compulsory when using the Ao transducer interface cable

If using direct aortic input into the Optical Unit via the Ao transducer interface cable (see section 4.6), aortic output to the Cathlab Hemodynamic System must also be used. For approved Cathlabs, OptoMonitor 3 can feed the aortic pressure signal coming from the transducer to the Cathlab Hemodynamic System by emulating a BP-22 compatible transducer so that real-time Pa pressure can be shown on the Cathlab monitor.

- 1- Connect the Pressure output cable (yellow plug) to a free transducer input of the Cathlab Hemodynamic System
- 2- Connect the Pressure output cable to the yellow port second from the left on the bottom row of ports on the Optical Unit (labelled Aortic Out).
- 3- From the Main Screen on the DU, navigate to Settings > Maintenance > Input/Output Calibration > Pa Source and select AUX.

4.8 Connecting Distal Output to Cathlab Hemodynamic- Optional

The OptoMonitor 3 has the capability to feed the distal pressure signal coming from the pressure guidewire to the Cathlab Hemodynamic System by emulating a BP-22 compatible transducer so that real-time Pd, Pd/Pa pressures can be shown on the Cathlab monitor.

- 1- Connect the Pressure output cable (yellow plug) to a free transducer input of the Cathlab Hemodynamic System.

2- Connect the Pressure output cable to the top-left yellow connector of the Optical Unit (labelled Distal Out).

NOTE: This is a low level (5 $\mu\text{V}/\text{V}/\text{mmHg}$) output of the distal pressure measured by the pressure guidewire. This output is intended to connect to a Cathlab Hemodynamic System with BP-22 compatible transducer input with sensitivity of 5 $\mu\text{V}/\text{V}/\text{mmHg}$.

4.9 Connecting DICOM

The OptoMonitor 3 has the capability to communication with the hospital DICOM Modality Worklist Server / RIS (Patient information retrieval) and DICOM Export to archive Server / SCP (image export).

When connecting to healthcare facility network, such as DICOM, connection shall be isolated. Connection to the hospital network is achieved using LAN1 port on the Display Unit.

The following information will be required in order to complete the Networking setup. This information is to be provided by the hospital staff, typically the bio-medical engineering group or IT department.

Can the OpM 3 use a DHCP server to automatically obtain an address? YES / NO

If **NO**, please provide the following information:

- Static IP address to use :

- Net Mask to use:

- Gateway to use:

DICOM Modality Worklist Server / RIS information

Please indicate the following information:

- DICOM Server Local AE title: _____ (Remote AE title on OpM3)
- DICOM Server AE host IP: _____
- DICOM Server Local port: _____
- DICOM Server Remote AE title: _____ (Local AE title on OpM3)

DICOM Export to archive Server / SCP information

Please indicate the following information:

- DICOM Server Local AE title: _____ (Remote AE title on OpM3)
- DICOM Server AE host IP: _____
- DICOM Server Local port: _____

- DICOM Institution Name: _____
- DICOM Server Remote AE title: _____ (Local AE title on OpM3)

4.10 Connecting an external screen

The Display Unit DU-10" is equipped with a VGA port and may be connected to an external screen using this port. The screen resolution of the DU-10" is 1920x1200.

The Display Unit DU-15" is equipped with an external output (VGA port and a DVI-D port or HDMI port depending on the DU-15" model). It may be connected to an external screen through one of these ports. The screen resolution of the DU-15" is 1024x768.

First, connect the external screen and then boot the Display Unit.

4.11 Connecting a wireless mouse

The display unit is equipped with USB ports and may be connected with a wireless mouse.

Mouse recommendation

- The wireless mouse is not provided with the OpM3 kit.
- The wireless mouse should use a generic HID drive. It has no specific driver.
- The range of the wireless mouse is compatible with the distance between your working position and the location of the USB connection.
- The wireless mouse is compliant with your local policies and regulations.
- Use of the wireless mouse should be done as per your hospital IT and/or security office to comply with internal cybersecurity policy and requirements.
- The mouse battery must be charged.

Mouse installation and use

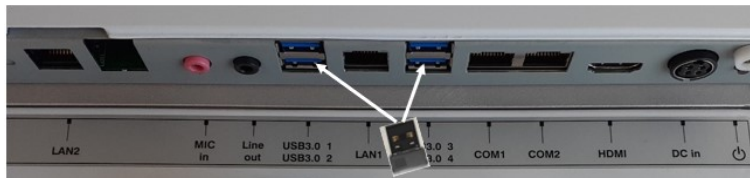

- The wireless emitter or dongle of your wireless mouse must be plugged on the USB port of the display unit.
- Use of the wireless mouse must consider prevention of patient area contamination

Mouse cleaning

- It is recommended to follow the mouse manufacturer's recommendations to clean the mouse.
- The mouse can not be sterilized.

Notice

- The USB port for the wireless mouse and the patient must not be touched simultaneously. For this purpose, it is mandatory to use a wireless mouse and not a wired mouse.
- Additional equipment is required to maintain the sterile field while using the wireless mouse.

5 INSTRUMENT SETTINGS

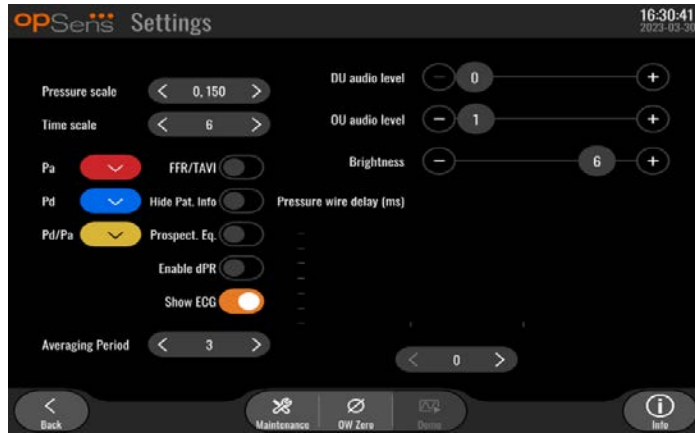

From the MAIN screen, tap the “Settings”  button to access the OptoMonitor 3 SETTINGS menu. Here you can select the pressure scale range, the time scale, the pullback time scale, colors for Pa, Pd, Pd/Pa, and dPR, adjust the DU audio level, adjust the OU audio level, adjust the screen brightness, switch from FFR to TAVI functionalities, hide or display the patient information, enable or disable prospective equalization, enable or disable dPR functionality, set the averaging period for dPR, set the pressure wire delay. The user can also initiate an OW zero from this menu if required, as well as perform maintenance on the device.

The Averaging Period is automatically reset at 3 beats after rebooting the DU. All settings are stored into non-volatile memory of the Display Unit.



When the transducer input is used for the aortic signal, the option to use the auxiliary input to display an ECG signal is available. The ECG signal can be displayed or hidden using the Show ECG setting.

5.1 dPR Mode

This setting is only available if the software has FFR/dPR capabilities. Check your activation key in Activation Management Menu to see what software features are available on your device.

5.1.1 dPR Disabled

When dPR mode is disabled, dPR is not displayed as a value in the data window, and the functions window loses its “dPR” and “dPR” pullback options.

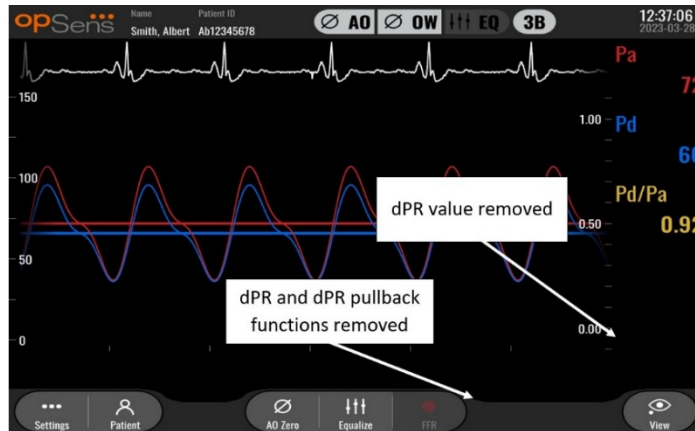

5.1.2 dPR Enabled

When dPR mode is enabled, dPR is displayed in the data window as normal and all previously described MAIN screen functions appear.

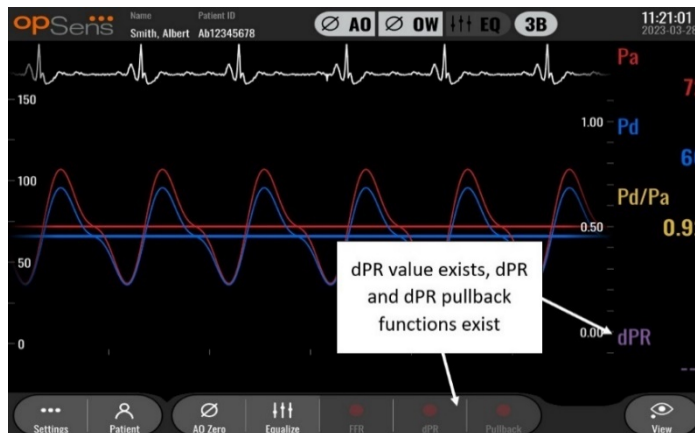

5.2 TAVI Mode

This setting is only available if the software has TAVI capabilities. Check your activation key in Activation Management Menu to see what software features are available on your device.

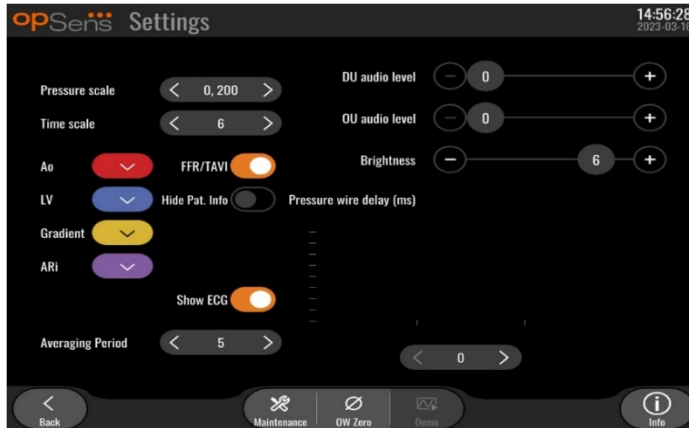

When FFR/TAVI is enabled, the signal labels, colors and averaging will change. These settings are independent from the settings available when TAVI is disabled. The average setting default value is 5 and is saved in non-volatile memory.

5.3 Prospective Equalization

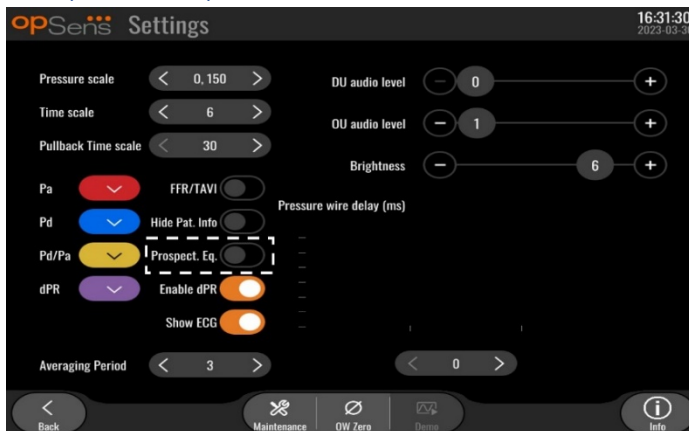

This setting is only available if the software has FFR/dPR capabilities. Check your activation key in Activation Management Menu to see what software features are available on your device. This setting only applies to FFR/dPR recordings.

Prospective Equalization can be enabled or disabled. By default, it is disabled. Whether prospective equalization is selected or not, the equalization calculation takes place over 4 beats.

If “Prospective Equalization” is disabled, then the 4 beats before the equalization button is pressed are used to perform the equalization. Therefore, equalization seems instant to the operator as there is no delay between the moment the operator presses on the equalization

button and the moment the equalization is done. However, the equalization button is only available once 4 beats have been recorded.

If “Prospective Equalization” is enabled, then the 4 beats after the button is pressed are used to perform the equalization. Therefore, equalization does not seem instant to the operator as there is a delay between the moment the operator presses on the equalization button and the moment the equalization is done.

5.4 Hide Patient Info

When Hide Patient mode is disabled, patient information is present on the MAIN screen.



When Hide Patient mode is enabled, patient information is absent from the MAIN screen.

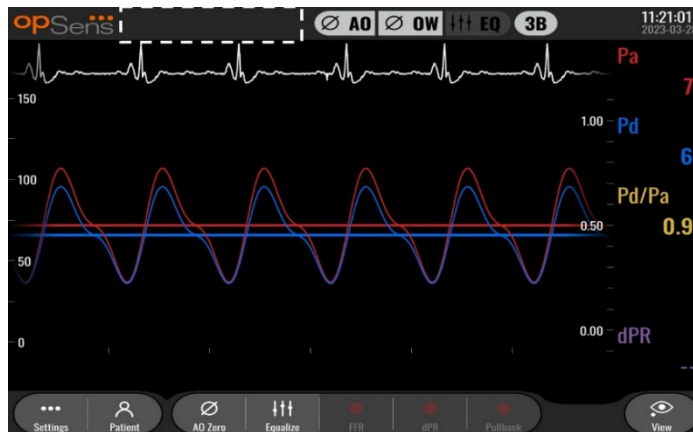

5.5 Show ECG

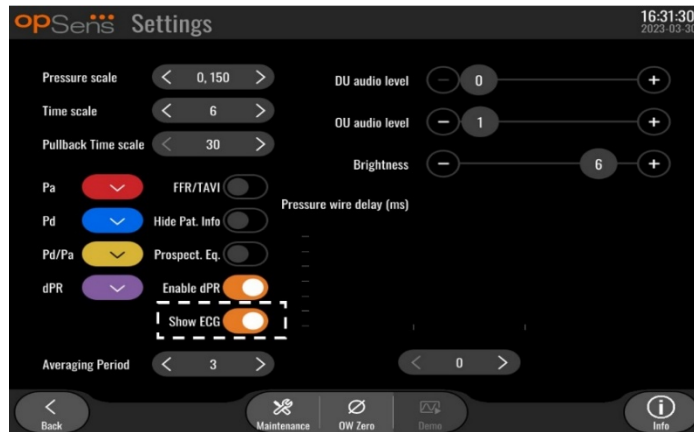

When the transducer input is selected as the aortic signal, the “Show ECG” setting becomes available. The auxiliary input can be connected to the Cathlab Hemodynamic system to receive an ECG signal. Enabling the setting will show the received signal in live and playback.

5.6 Pressure Scale

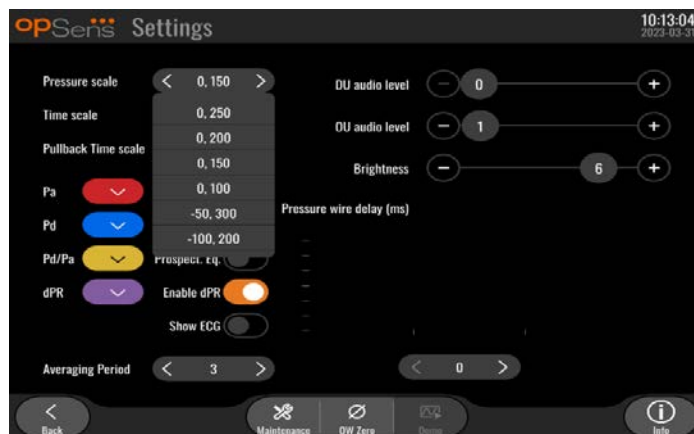

- Press the pressure scale button to access the pressure scale adjustments.
- Select the scale between 0 to 250, 0 to 200, 0 to 150, 0 to 100, -50 to 300, or -100 to 200 when the dropdown menu appears.

5.7 Time Scale



- Press the time scale button to access the time scale adjustments.
- Select the time scale between 3 s, 6 s, 15 s, or 30 seconds by screen view when the dropdown menu appears.

5.8 Pullback Time Scale

The pull back time scale allows to view the whole dPR pullback curve in the same view.



- Press the Pullback time scale button to access the time scale adjustments.
- Select the time scale between 30, 45, 60 or 75 seconds by screen view when the dropdown menu appears.

5.9 Color Selection

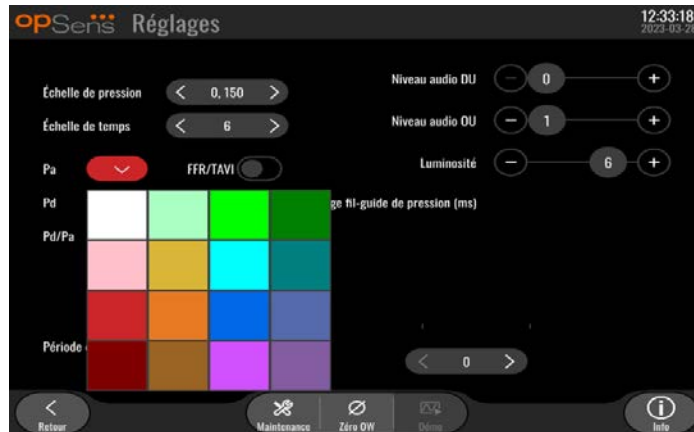

- Press the colored square underneath the pressure curve/calculation you wish to change.
- Select a color from the color pallet that appears. Ensure each pressure curve/calculation is your desired color. To avoid confusion, it is advised that each pressure curve/calculation is unique from the others.

5.10 Audio and Brightness level



Select which option you wish to adjust (DU audio, OU audio, or DU screen brightness) and drag the scale left or right until you are satisfied with the adjustment.

5.11 Averaging period

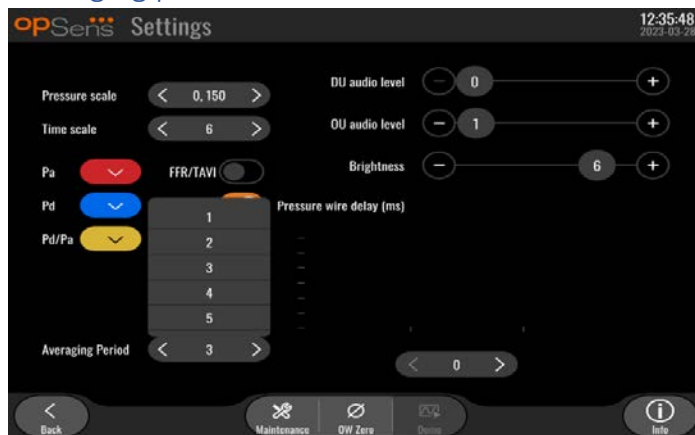

- Press the averaging period button to access the averaging period adjustments.
- Select the number of pulse beats over which to average aortic and distal pressures, between 1, 2, 3, 4, or 5 beats when the dropdown menu appear.
- Edition of this setting is reflected on the top of the MAIN SCREEN and the averaging used for a recording is displayed on the top of the VIEW SCREEN.

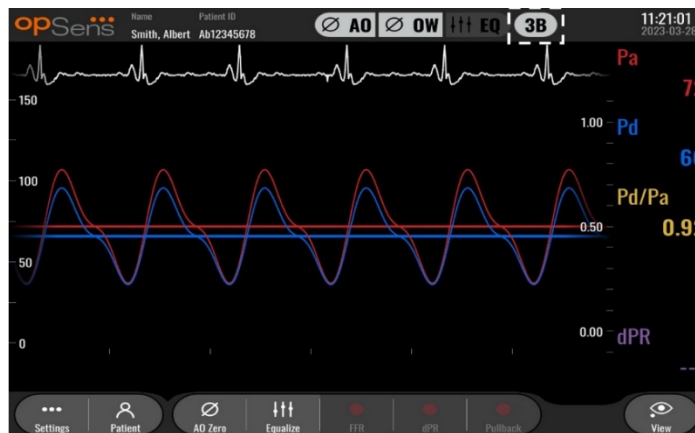

NOTE: This does not apply to dPR and dPR pullback recordings.

CAUTIONS:

An insensitive or overly sensitive averaging of pressure may result in an incorrect FFR/dPR/Gradients/ARi/TIARi value.

- Choosing a high number of heartbeats will make the pressure averaging slower and less sensitive to artefacts but may also result in overly insensitive averaging which is noticeable when there is a short hyperaemic plateau.
- Choosing a low number of heartbeats makes the pressure averaging faster and more sensitive to pressure changes, desirable using a short hyperaemic plateau, but it may also result in an averaging overly sensitive to arrhythmia and pressure disturbances.

5.12 Pressure Wire Delay

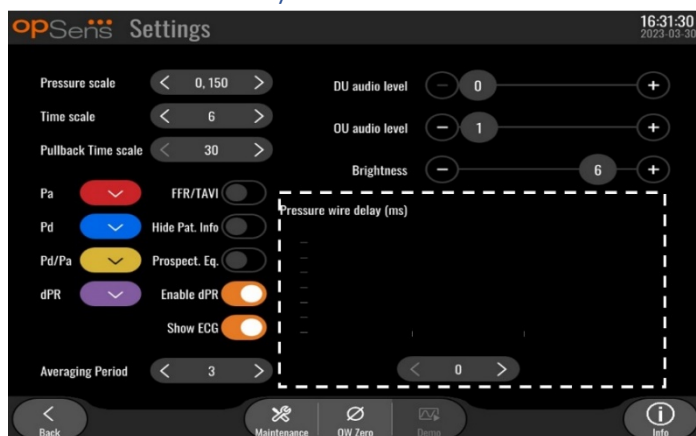

In some cases, lag between pressure guidewire and aortic pressure can be experienced due to the two pressure curves coming from two different sources (Cathlab Hemodynamic System/aortic transducer vs OpSens guidewire). This lag can be corrected using the pressure wire Delay button.

1. Press the ">" arrow once to increase the wire delay by 8 ms
2. If delay was accidentally set too high, press the "<" arrow once to decrease the delay by 8 ms.
3. Repeat the process of increasing/decreasing delay by 8 ms until both curves are perfectly in sync.

- The Pressure wire delay can be adjusted automatically by pressing the Auto button. Auto button appears when clicking on the delay number between “<” and “>” arrows.

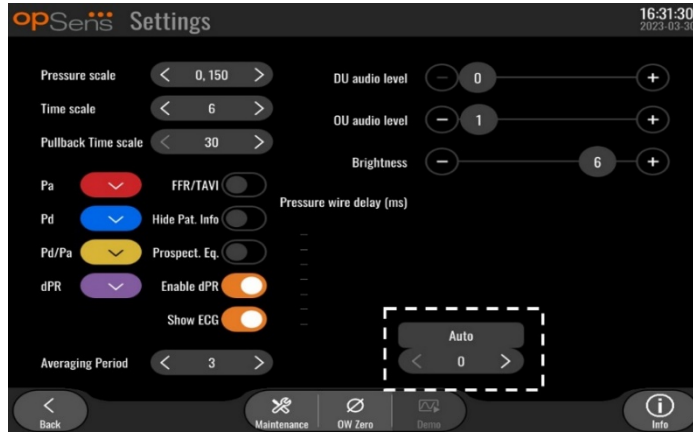

- The adjustment can be finalised by pressing the “<” or “>” arrow.

5.13 Input/Output Calibration with Cathlab Hemodynamic System, and Time/Date/Language Adjustments via the Maintenance Menu

5.13.1 Accessing the Input/Output Calibration Menu

- From the Settings screen, press the Maintenance button. This will take you to the Maintenance menu.



- Enter the maintenance access code and press the green V to continue. Refer to section 8.12 for default values.
- Press Input/Output Calibration button

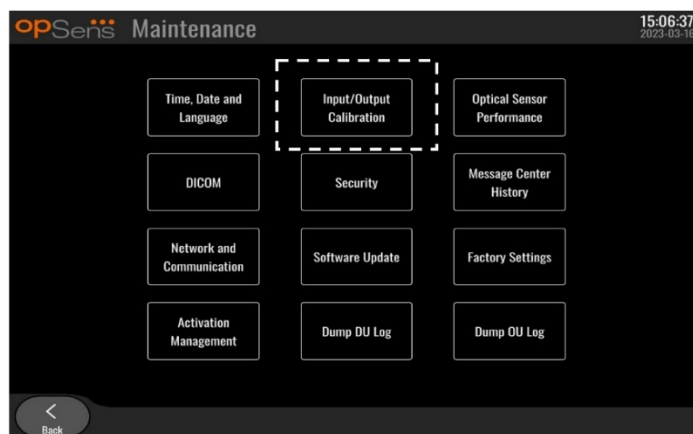

4. Input/Output Calibration screen will be shown:

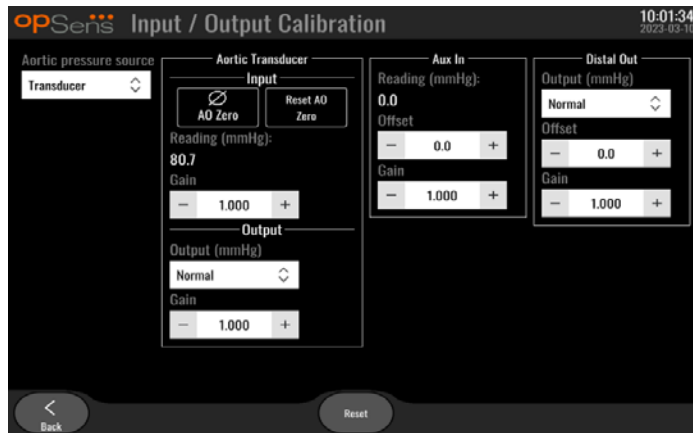

Refer to Sections 17, 18, 19 and 20 for step-by-step calibration procedures.

5.13.2 Adjusting Time, Date and Language

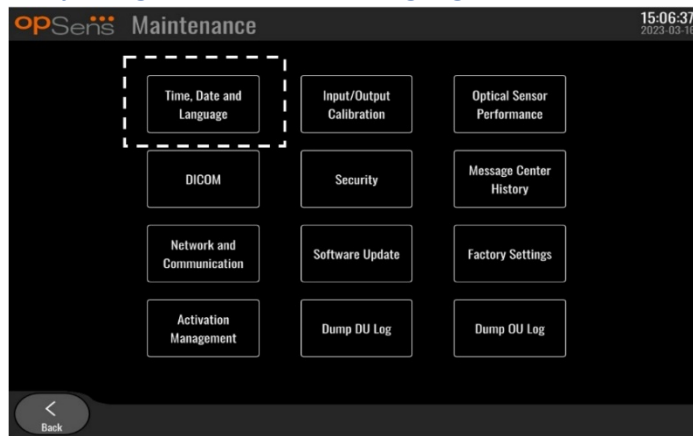

Time, Date and Language screen will be shown.

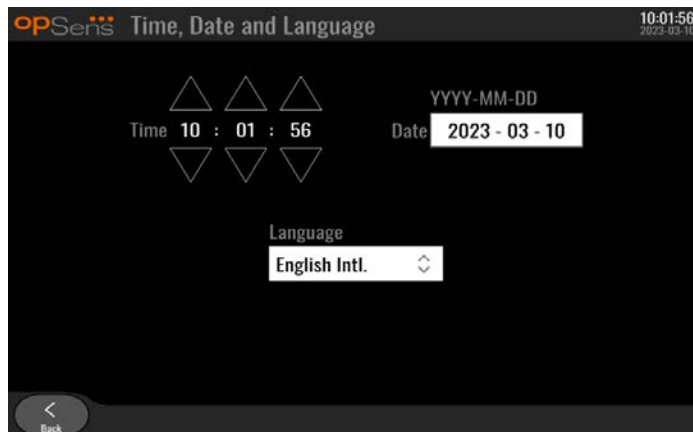

Adjustments are detailed in section 8.2.

5.14 Activation Key

The OpM3 requires an activation key to unlock the software’s functionalities. Without the activation key, the main window offering pressure readings and recording capabilities won’t be available. It will not be possible to exit the settings page as the “back” button will be grayed out. To activate the software’s functionalities, an activation key is needed. It can be found on the activation card. Each activation key is unique to one Display-Unit.

5.14.1 Activation card

The activation key can be found on the activation card. The activation key is on a peel-off section. It is recommended to stick it on the back of the Display-Unit.

Each activation key is unique to one Display-Unit.

If new software functionalities are needed, an activation card can be ordered from OpSens. See section [ORDERING INFORMATION](#).

5.14.2 Activation Management menu

At the first start-up of the Display Unit, a pop-up window will suggest entering the activation key.



To enter the activation key, hit “activate”. This will open the Activation Management menu.

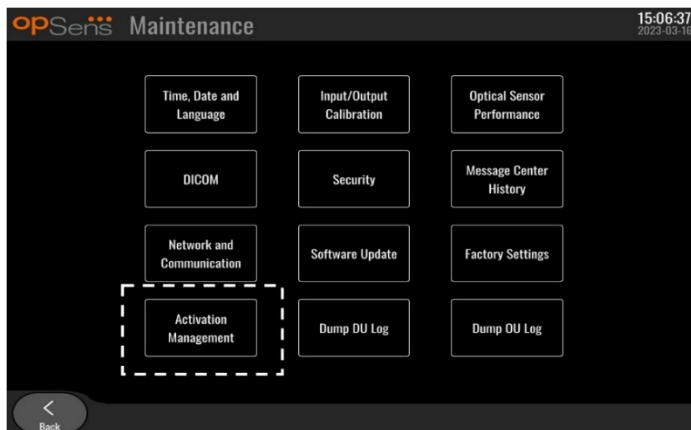

The Activation Management menu can also be accessed at any time from the settings page:

1. Hit the maintenance button.
2. Enter the maintenance access code.

3. Press the green V to continue.
4. Hit Activation Management.



5.14.3 Activating the software

From the Activation Management window, enter the activation key found on the activation card. Then, hit Activate. The software capabilities after activation will be displayed next to description and the main window is now available. The following table explains the different software features available after activation.

Current Key Description	Software features
No Key	There is currently no activation key. The main screen offering pressure readings and recording is not available. It is not possible to exit the settings screen. The maintenance screen is available.
FFR/dPR only	Software is limited to use with FFR/dPR capabilities.
FFR/dPR + TAVI	Software can be used with both FFR/dPR and TAVI capabilities.
TAVI only	Software is limited to use with TAVI capabilities.

5.14.4 Edit or remove the activation key

It is not necessary to remove the current activation key before entering a new one. The new one will replace the old one.

It is possible to remove an existing activation key by hitting the remove button. A confirmation pop-up will appear:

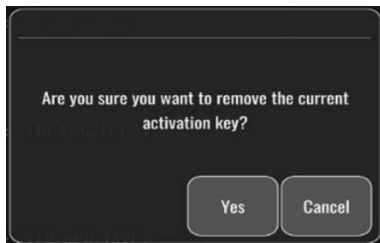

If “yes” button is pressed, it will then no longer be possible to exit the settings window until a new activation key is entered.

6 PATIENT CASE MANAGEMENT

6.1 Opening a New Case

6.1.1 Opening a New Case Without DICOM

It is required that patient ID be set up **BEFORE** each case. Until the user manually inputs this information, the system does not consider a case to be open, and saves any recordings made as “NoPatient”. To open a case:

- Navigate to the patient information screen, via the MAIN screen.
- Enter information for all required fields. Fields must not include following characters < > : “ / \ | ? *

The screenshot shows the 'Patient Information' screen in the OP Sens application. The interface is dark-themed with white text. At the top left is the 'OP Sens' logo and 'Patient Information' title. At the top right is a timestamp '10:24:25' and '2023-03-10'. The form contains several input fields: 'Last Name' (Smith), 'First Name' (John), 'Performing Physician' (Dr.), 'Middle Name' (N.), 'Patient ID*' (1234s56789), 'Gender' (<M>), 'Date of Birth' (1961-06-25), 'Procedure Date' (2023-03-10), 'Study Description', and 'Accession Number'. A note at the bottom states: '*This field is required to begin a case' and 'Fields must not include following characters < > : “ / \ | ? *'. At the bottom of the screen are three buttons: 'Back', 'Clear info', and 'DICOM list'.

NOTE: Ensure that all information entered is correct in all relevant fields before moving onto next step. Otherwise, the section with special characters will change of color notifying that changes are needed.

Once a recording is made using a specified patient ID, patient ID cannot be changed.

- Exit the screen with the back button to save patient information. This “opens” the case under this patient ID.

Return to the MAIN screen. Selecting any of the measurement functions. (FFR, dPR, dPR pullback, TAVI record) will begin a recording that will save under the patient’s ID information.

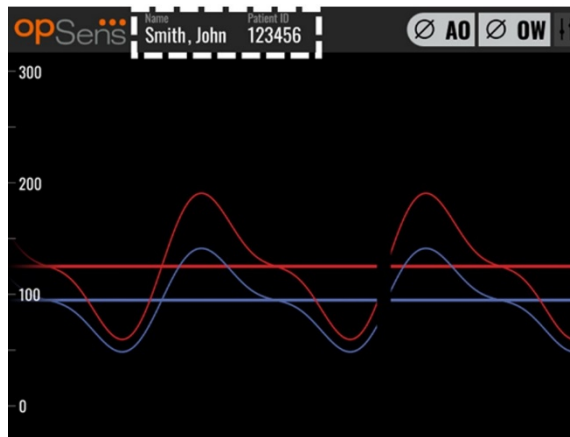

Case open for Patient:
 "Smith, John", Patient ID:
 123456.

Note that patient name
 and ID appears in the
 information window, and
 all recordings saved under
 this case "123456" appears
 in recordings selection box.

You can upload any recordings via USB export. ([see Archiving and Deleting Data](#) for more information).

6.1.2 Opening a New Case from DICOM List

If DICOM between OptoMonitor 3 and Cathlab is successfully connected, the user can upload patient information from a DICOM list.

- Navigate to the patient information screen, via the MAIN screen.
- Press the "DICOM List" button.

- Locate the desired patient in the DICOM list. The list of patient data can be scrolled through by using the touch interface to swipe up/down the list.
- Tap the desired patient data and press the "Select" button, which is the second button located at the bottom row of the screen.

Patient ID	Patient Name	Accession Number	Date of Birth
1234 17.P17	Côté, Etienne France	84392712	1971-09-17
123459.P09	Patient, 9	86881610	1979-11-09
123458.P08	张, 伟	00000130	1981-05-25
123457.P07	Patient, 7	00000129	1975-10-17
123456.P06	Patient, 6	00000128	1939-07-29
123455.P05	Patient, 5	00000127	1991-02-25
123454.P04	Patient, Four	00000126	1975-03-29
123453.P03	Patient, 3	00000125	1989-01-27
123452.P02	山田, 太郎	32679480	1979-02-03
1234519.P21	Doe, John	17089198	1953-06-13
1234519.P20	Doe, John	17089198	1953-06-13

- The screen will switch to the patient information screen. All patient information fields will auto-fill. Confirm that all relevant fields are expected and accurate. If yes, exit with the back button. This fills the patient information screen with information from the selected patient via DICOM.

Return to the MAIN screen. Selecting any of the measurement functions (FFR, dPR, dPR pullback, TAVI record) will begin a recording that will save under the patient’s ID information. Once you have completed a recording for this case, the file will appear in local files. You can upload any recordings via USB export or DICOM.

WARNING:

Valid patient ID **MUST** be inputted into patient information in order to progress through patient case management process. If a valid patient ID is not given, the case will not open, and any recordings will be saved under the file format “NoPatient...”.

6.1.3 Refreshing the DICOM list

At the top of the DICOM list is displayed the last saving date/time. This information is updated:

- when the Refresh button is selected.
- when the DU is rebooted and the DICOM is connected.

If the DU is rebooted but the DICOM is disconnected, a pop-up window is displayed to inform the user that the DU failed to retrieve the DICOM list.

However, if the DU was connected and then disconnected without rebooting the DU, then the latest retrieved DICOM list is displayed, without a pop-window to inform the user.

6.2 Ending an Open Case/ Starting a Second Case

To end an open case:

Option 1:

- Navigate to the patient information screen via the MAIN screen.
- Press the “New Case” button, which is the first button at the bottom of the screen. This ends the previous case and allows the user to begin inputting new patient information.

opSens Patient Information 14:30:05
2023-03-16

Last Name: Holly First Name: Davis Performing Physician: Dr.

Middle Name: N. Patient ID*: As12345678 Gender: < F > Study Description:

Date of Birth (YYYY-MM-DD): 1961 - 03 - 10 Procedure Date (YYYY-MM-DD): 2023 - 03 - 16 Accession Number:

*This field is required to begin a case

Fields must not include following characters < > : * / \ | ? *

Back New case DICOM list

- the steps outlined above (6.1) to begin a new case.

Option 2:

- When viewing the patients’ recordings in the view screen, press the “Close Case” button.

7 PERFORMING a PROCEDURE

Cut off values for both index	
Fractional Flow Reserve (FFR), hyperemic index	0.80 ¹
Diastolic Pressure Ratio (dPR), non-hyperemic resting gradient index	0.89 ²³⁴⁵

Summary of dPR Validation Study

The correlation between dPR and iFR⁴ is documented in OpSens test report REP-2011-14. The accuracy, sensitivity, and specificity of dPR compared to iFR used as a reference standard was assessed using 254 valid tracings from the VERIFY 2⁶ study combined with 608 valid tracings from the CONTRAST⁷ study.

OpSens has shown that the accuracy, specificity and sensitivity of dPR compared to iFR as a reference standard⁴, with a cut-off value of 0.89 and using both CONTRAST and VERIFY 2 studies, are 97.1% [95.7%, 98.1% at 95% CI], 95.9% [93.6%, 97.5% at 95% CI] and 98.4 % [96.6%, 99.3% at 95% CI] respectively.

The coefficient of correlation and the AUROC (area under the Receiver Operator characteristics curve) are both above 0.99, indicative of a very high correlation between dPR and iFR.

¹ Levine et al. 2011 ACF/AHA/SCAI PCI guideline for Percutaneous Coronary Intervention; Journal American College of Cardiology 2011, 58:44-122.

² Davies JE, Sen S, Dehbi H-M, et al. Use of the instantaneous wave-free ratio or fractional flow reserve in PCI. N Engl J Med 2017;376:1824-34.

³ Gotberg M, Christiansen EH, Gudmundsdottir IJ, et al. Instantaneous wave-free ratio versus fractional flow reserve to guide PCI. N Engl J Med 2017;376:1813-23.

⁴ An iFR cut-point of 0.89 matches best with an FFR ischemic cut-point of 0.80 with a specificity of 87.8% and sensitivity of 73.0%. (From ADVISE II and iFR Operator's Manual 505-0101.23).

⁵ Van't Veer, M. et al. J Am Coll Cardiol. 2017; 70 (25):3088-96.

⁶ Hennigan B. et al., "The VERIFY 2 Study (A Comparative Study of Resting Coronary Pressure Gradient, Instantaneous Wave-Free Ratio and Fractional Flow Reserve in an Unselected Population Referred for Invasive Angiography)", Circ Cardiovasc Interv. 2016 Nov;9(11)

⁷ Nils P. Johnson et al., "Continuum of Vasodilator Stress From Rest to Contrast Medium to Adenosine Hyperemia for Fractional Flow Reserve Assessment", JACC : Cardiovascular Interventions, Vol. 9, No. 8, 2016.

dPR vs iFR Statistical performance (CONTRAST+VERIFY 2 (Rest 1) studies)

dPR vs iFR diagnostic values (all using 0.89 cutoff)			
			Confidence at 95 %
Accuracy	97.1 %	(837/862)	[95.7 %, 98.1 %]
Specificity	95.9 %	(418/436)	[93.6 %, 97.5 %]
Sensitivity	98.4 %	(419/426)	[96.6 %, 99.3 %]
Other statistics			
Mutual differences			0.0006 ±.0106 std
Coefficient of correlation (R²)			0.992
AUROC			0.9992

The diagnostic performance of dPR (cut-off = 0.89) vs FFR (cut-off = 0.80) compared to iFR (cut-off = 0.89) vs FFR (cut-off = 0.80) was also assessed in OpSens test report REP-2011-07. It was demonstrated that the diagnostic performance of dPR vs FFR is not statistically different from the diagnostic performance of iFR vs FFR, with 95 % confidence interval significantly overlapping.

The OptoMonitor 3 is intended to be used with OpSens' pressure guidewire devices.

OpSens' pressure guidewire devices are available in two different models:

- Pressure devices WITH Gauge Factor Connector (device label indication).
- Pressure devices WITHOUT Gauge Factor Connector (device label indication).

NOTES:

- Sensor calibration information of pressure guidewire **WITHOUT** Gauge Factor Connector is contained within the guidewire cable and does not need a Gauge Factor Connector.
- Sensor calibration information of pressure guidewire **WITH** Gauge Factor Connector is contained within Gauge Factor Connector.

7.1 Starting the System

Before using the OptoMonitor 3 and OpSens pressure guidewire, read the Instructions for Use accompanying the product.

NOTE: A warm up period (approximately 20 minutes) before a procedure is recommended.

1. Press the POWER switch, located on the underside of the unit, towards the right side of the device.
2. A single medium tone will sound from the DU, and the OpSens logo will appear.
3. Wait until the MAIN menu is displayed and fully loaded (approximately 10 seconds).

7.2 Verifying Optimal Aortic Pressure Waveform and ensuring Ao Zero

7.2.1 Using Aortic Input from Cathlab Hemodynamic System

1. Perform aortic input calibration of the Cathlab Hemodynamic System (via steps outlined in section 8.3.2).
2. As per standard procedure, open aortic pressure transducer line to air by properly positioning stopcock valve and ensure hemodynamic system aortic pressure (Pa/Ao) is properly zeroed.
3. The guiding catheter should be frequently flushed with normal saline to ensure an optimal aortic pressure waveform (without oscillation or damping) is obtained.
4. **Ensure the aortic signal displayed on Display Unit (DU) is equal to zero (0) before continuing.**

If Ao has been zeroed successfully, continue to section 7.3 Connect the FOIC Connector to the OptoMonitor 3 Handle Unit.

7.2.2 Using Aortic Input from the Aortic Transducer (Use with BP-22 compatible transducer)

1. Perform aortic input calibration of the aortic transducer (via steps outlined in section 8.3.1).
2. As per standard procedure, open aortic pressure transducer line to air by properly positioning stopcock valve and ensure transducer aortic pressure (Ao/Pa) is properly zeroed.
3. The guiding catheter should be frequently flushed with normal saline to ensure an optimal aortic pressure waveform (without oscillation or damping) is obtained.
4. **Ensure the Ao/Pa displayed on Display Unit (DU) is equal to zero (0) before continuing.** If aortic value displayed on DU is not equal to Zero, press the Zero button to perform an Ao zero adjustment.
 - Press the Ao Zero button on the MAIN screen.
 - A warning message will appear, warning the user to ensure transducer zero has been performed.
 - Press the “YES” button if the transducer zero has been performed on the aortic pressure channel.
 - Press the “NO” button if the transducer zero has not been performed on the aortic pressure channel.
 - Proceed with transducer aortic channel zero and check the DU for zeroing again. Repeat from the Ao Zero button step if still not zeroed.
5. Ao zero has been completed when the message “Aortic Zero successful” appears in the message window, display shows **0AO** in the top left-hand corner and the Pa on the Display Unit shows “0”. Once performed successfully, proceed to step **7.3 Connect the FOIC Connector to the OptoMonitor 3 Handle Unit**

If the Ao Zero failed, the message “**Aortic zero failed!**” is shown. Verify that the Ao is open to air, all connections properly established and press the Ao Zero button again. In the case where Ao has been zeroed once, and a zero value is stored in the memory, the message “**Aortic zero failed, old value used**”.

NOTE: The BP-22 compatible transducer is not supplied with the OpM3 system.

7.3 Connect the FOIC Connector to the OptoMonitor 3 Handle Unit

1. Leave the pressure wire in the tray.
2. Place the tray/hoop flat on the table.
3. Connect the FOIC connector (green connector) into the Handle Unit.
4. For pressure guidewire device model **WITHOUT** Gauge Factor Connector, proceed to section **7.4 Zeroing pressure guidewire to Atmosphere**.
5. For Pressure Guidewire device model **WITH** Gauge Factor Connector, insert the matching Gauge Factor Connector into the Handle Unit narrow opening beside the LED indicator.

Orientation is not important.  → Gauge Factor Connector (GFC)

WARNINGS:

- Use only the corresponding pressure guidewire Gauge Factor Connector and cable supplied in the same tray.
- The use of mismatched Gauge Factor Connector and cable with pressure guidewire will affect the measurement accuracy.

NOTE: The guidewires are not supplied with the OpM3 System.

7.4 Zeroing pressure guidewire to Atmosphere

7.4.1 Automatic Zero

Zero must be completed before inserting the pressure guidewire into the patient.

1. The OptoMonitor 3 system will attempt to perform an auto zero once all components and connections are in place.
2. The message “[...] **zero in progress...**” appears on the Message window and a green LED flashing for a few seconds on the Handle Unit.

The  icon at the upper left corner of the MAIN screen confirms a successful pressure guidewire zero. The third LED indicator on the top row of the Optical Unit will also flash green to indicate successful zeroing.

3. Flush the pressure wire vigorously with standard saline solutions, remove from the tray. The pressure guidewire is ready to be used.

7.4.2 Manual Zero

In some rare cases, the guidewire may need to be zeroed manually by the user

- 1- Ensure the pressure guidewire remains flat on the table, still in the tray and exposed to atmosphere.
- 2- Access the SETTINGS menu.
- 3- Press the “OW Zero” button located along the bottom of the screen.



4. The system will begin zeroing. A message “Zero in progress...” will appear in the message center in the MAIN screen.
5. The  icon at the upper right corner of the MAIN screen confirms a successful zero. The third LED indicator on the top row of the Optical Unit will also stay steady green to indicate successful zeroing.
6. Flush pressure guidewire vigorously with standard saline solutions, remove wire from the tray. The OpSens pressure guidewire is ready to be used.

WARNING:

The OptoMonitor 3 will not zero (either automatically or manually) should the pressure reading vary, for example detecting pulsatile blood pressure inside a patient.

7.5 Equalization

7.5.1 FFR/dPR procedure equalization

Pressure equalization is done in two successive steps:

- Step 1: Pa/Pd equalization.
- Step 2: dPR factor equalization.

Step 1 takes up to 4 beats to complete while step 2 requires a minimum of 4 beats.

Once Step 1 and 2 are completed, the calculated correction factor is applied to the signal thus gradually changing the averaged values displayed over the next few beats (number of beats depends on averaging period).

1. Close the stopcock, remove the guidewire introducer, close the Y connector valve and flush the catheter with saline.
2. Verify Pd is equal to Pa.
3. Press the EQUALIZATION button to begin equalization of the Pd (pressure guidewire) and Pa (aortic) readings. The message window will show the “Equalization in progress” message. After a short time, the message will update to “Equalization successful” if equalization has been performed properly, otherwise it will show “Equalization failed”, and this step will have to be repeated.

4. When equalization is completed, the  icon appears on the top right corner of the screen, and the fourth LED indicator on the top row of the Optical Unit will also stay steady green to indicate successful equalization.
5. Verify visually that pressure guidewire (Pd) reading is equal to aortic (Pa) reading. If not, re-perform equalization.

NOTE: See sections 11.5 for troubleshooting.

Pa and Pd curves delay adjustment during Equalization

A message “Please Adjust Pa Pd Delay” is prompted if there is a delay between the Pa and Pd curves. Follow section 5.12 for instructions on adjusting Pd delay.

7.5.2 TAVI procedure equalization

The TAVI procedure equalization requires multiple beats. The equalization attempts to use the previous last 3 beats. Systolic and diastolic values will match after successful equalization if no artifact is present in the signal such as overdamping and underdamping.

Once completed, the calculated correction factor is applied to the signal thus gradually changing the values displayed.

1. Ensure a catheter is positioned in the ventricle. Use catheter size and type that are appropriate for pressure measurement.
2. After flushing the SavvyWire™ (refer to SavvyWire™ IFU), connect its insertion tube with hemostasis valve to the catheter.
3. Verify that the aortic transducer is zeroed and level with the heart. Connect it to the injection port of the hemostasis valve.
4. Flush the transducer line and catheter with saline. Ensure there is no air bubble.
5. Verify both signals. They should be devoid of artifacts and measure at the same location.
6. Ensure the hemostasis valve containing the sensor of the SavvyWire™ is level with the heart.
7. Press the EQUALIZATION button.
8. The message window will show the “Equalization in progress” message. After a short time, the message will update to “Equalization successful” if equalization has been performed properly, otherwise it will show “Equalization failed”, and this step will have to be repeated.
9. When equalization is completed, the  icon appears on the top right corner of the screen, and the fourth LED indicator on the top row of the Optical Unit will also stay steady green to indicate successful equalization.
10. Both the amplitude and the offset of the pressure guidewire should match with the Ao signal. This can be verified with the systolic and diastolic values.

NOTE: See sections 11.5 for trouble shooting.

Wire delay adjustment during Equalization

A message to adjust wire delay is prompted if there is a delay between the Ao and LV curves. Follow section 5.12 for instructions on adjusting delay.

7.6 Performing an FFR Procedure

Advance OptoWire™ pressure sensor distal to the stenosis per recognized FFR procedures.

7.6.1 Inducing Maximum Hyperemia

Use your Cathlab practice to induce maximum hyperemia.

7.6.2 Recording Pressure – FFR

1. Make sure the interface is set to FFR and not TAVI. This can be changed in the settings menu or upon connection of an OptoWire™.
2. From the MAIN screen, press the FFR button on the Display Unit Screen to start recording pressure. (The OptoMonitor 3 can record sequences over a total recording period of 2 hours).



3. The minimum Pd/Pa tracking automatically starts when the FFR button is pressed.

NOTE: The minimum Pd/Pa value may not be the minimum FFR value due to artifacts. When finished recording, ensure to place the cursor on the minimum FFR value in playback mode by pressing the Pd/Pa button.

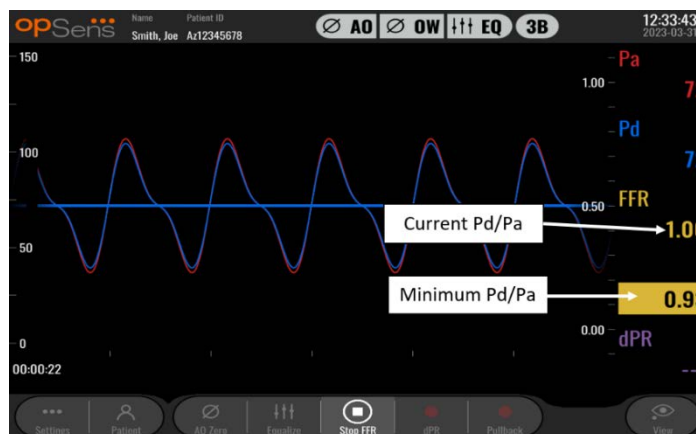

4. During recording, tap the graphic area twice to create a marker (solid white line).

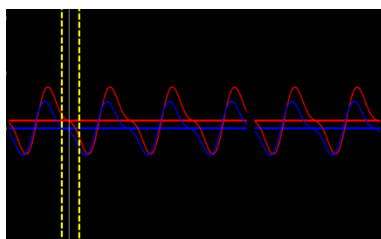

5. Press the “Stop FFR” button to end the recording. The screen will switch to playback mode (see section 7.8.1 for a more detailed explanation of FFR playback).



6. To make another recording, from the playback screen press the live button and restart the process from the beginning of 7.6.2.

7.7 Performing a dPR Procedure

Advance OptoWire™ pressure sensor distal to the stenosis per recognized FFR procedures.

7.7.1 dPR Calculation

1. Make sure the interface is set to FFR and is not TAVI. This can be changed in the settings menu or upon connection of an OptoWire™.
2. From the MAIN screen, press the “dPR” button to trigger a dPR recording.



3. You can track the progress of the dPR recording by a progress bar located in the bottom portion of the information bar. NOTE: Progress bar will change color according to your settings.



4. The OptoMonitor 3 will automatically switch to playback mode when the recording is complete. See section 7.8.2 for more details on dPR playback screen.
5. To make another recording, press the live button from the playback screen and restart the process from the beginning of 7.7.1.

7.7.2 Performing a dPR Pullback

1. From the MAIN screen, press the “dPR Pullback” button to initiate a dPR pullback recording.



2. The OptoMonitor 3 requires approximately 2 seconds after pressing the dPR pullback button before pullback recording is ready. Wait until the live dPR curve (default purple) begins tracing at a value above “0” before performing the pullback. During the pullback recording, current dPR value will be displayed in the bottom of the data window.



3. During the recording, tap the graphic area twice to create a marker (solid white line).

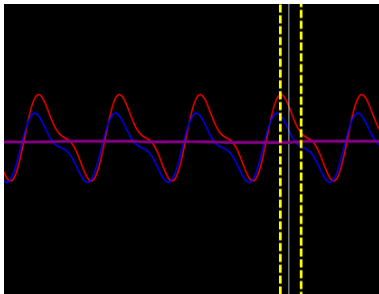

4. Press the “Stop Pullback” button to end the recording. The screen will switch to playback mode. See section 7.8.3 for more details of dPR pullback playback.
5. To make another recording, press the live button from the playback screen and restart the process from the beginning of 7.7.

7.8 Viewing FFR, dPR, and Pullback in Playback Mode

7.8.1 Viewing FFR in Playback Mode

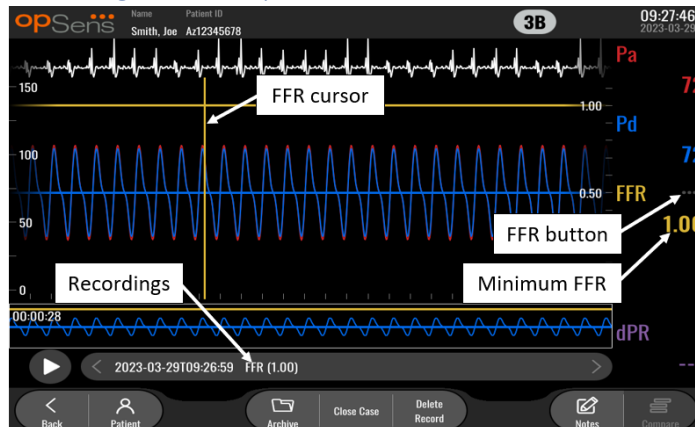

1. Upon completion of an FFR recording, the screen will switch to playback mode where the user can see all the recorded data of the current patient. If you wish to access playback mode without performing a recording, press the “View” button on the MAIN screen.
2. All locally stored recordings for the current patient will appear in the recording selection box. If no case is open, all non-case recordings will appear in the selection box. The user can use their finger to scroll up/down to view all locally stored recordings and can tap a desired recording to load it into the graphical window and data window.
3. FFR is calculated as mean Pd/mean Pa at the point of maximum hyperemia.
4. The minimum FFR value calculated over the length of the recording is displayed in the data window under “Pd/Pa” (default yellow). Minimum FFR is also marked by a yellow line in the graphical window. Live values of FFR are defined by the right axis of the graph.
5. The user can use their finger to scroll the marker left/right to view specific sections of the recording and identify regions of interest. Pa, Pd, and FFR will update in the data window as the marker moves.
6. The FFR button localizes the minimum FFR value within the entire recorded data and updates Pa, Pd, and FFR values in the data window.
7. The user can apply the ‘patient’ and ‘segments’ functions to the recording, as well as upload the recordings to a USB drive (or through DICOM export).

NOTE: When saving FFR recording to an USB key or via DICOM, ensure to place the FFR Cursor to the correct FFR value on the DU in the Playback mode so that the OptoViewer will open the FFR recording with the correct FFR Cursor position.

8. Pressing the “Play” button will cause the recording to replay as if it was a live measurement, from time = 0 seconds. During this replay, the live value of FFR is displayed in the bottom of the information window. Press the “Stop” button at any time during the replay to end it and return to the playback screen.
9. The Archive button enables the viewing of all previous recordings. Accessing this menu will close an on-going current case hence it should be accessed only when all recordings are completed.
10. Pressing the “Live” button sends the screen back to the MAIN screen, where live measurements resume, and another recording can be initiated.

7.8.2 Viewing dPR in Playback Mode

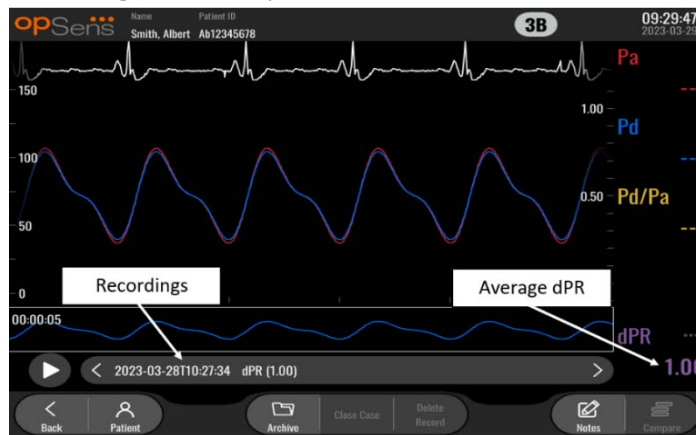

1. Upon completion of a dPR recording, the screen will automatically switch to playback mode where the user can see all the recorded data of the current patient. If you wish to access playback mode without performing a recording, press the “View” button on the MAIN screen.
2. All locally stored recordings for the current patient will appear in the recording selection box. If no case is open, all non-case recordings will appear in the selection box. The user can use their finger to scroll up/down to view all locally stored recordings and can tap a desired recording to load it into the graphical window and data window.
3. dPR is calculated using OpSens own algorithm during the diastolic period of the pressure wave (heart at rest).
4. 4 beats are used to calculate the single dPR measurement and is displayed in the bottom of the data window (default purple).
5. The user can apply the ‘patient’ and ‘segments’ functions to the recording, as well as upload the recordings to a USB drive (or through DICOM export).
6. Pressing the “Play” button will cause the recording to replay as if it was a live measurement, from time = 0 seconds. Press the “Stop” button at any time during the replay to end it and return to the playback screen.
7. Pressing the “Live” button sends the screen back to the MAIN screen, where live measurements resume, and another recording can be initiated.

7.8.3 Viewing dPR Pullback in Playback Mode

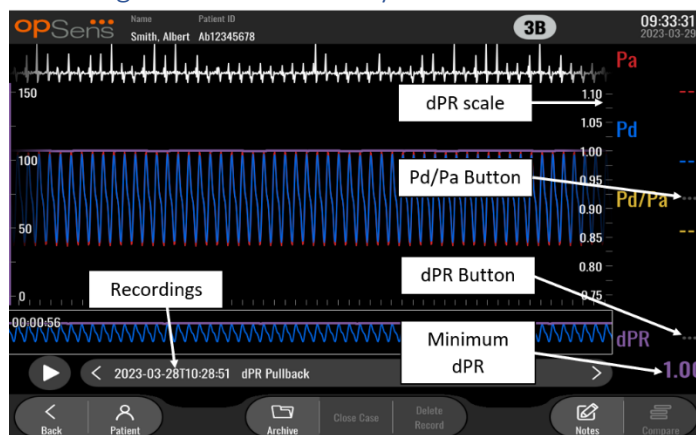

1. Upon completion of a dPR Pullback recording, the screen will automatically switch to playback mode where the user can see all the recorded data of the current patient. If you wish to access playback mode without performing a recording, press the “View” button on the MAIN screen.
2. All locally stored recordings for the current patient will appear in the recording selection box. If no case is open, all non-case recordings will appear in the selection box. The user can use their finger to scroll up/down to view all locally stored recordings and can tap a desired recording to load it into the graphical window and data window.
3. A dPR Pullback records a live calculation of dPR while the physician pulls the sensor wire across a lesion or area of interest.
4. The minimum (non-zero) dPR value calculated over the length of the recording is displayed in the data window under “dPR” (default purple). Minimum dPR is also marked by a purple line in the graphical window. The live dPR value is defined by the right axis of the graph.
5. The user can use their finger to scroll the marker left/right to view specific sections of the recording and identify regions of interest. dPR values in the data window will update as the marker moves.
6. The dPR button localizes the minimum dPR value within the entire recorded data and updates the dPR value in the data window.
7. The user can apply the ‘patient’ and ‘segments’ functions to the recording, as well as upload the recordings to a USB drive (or through DICOM export).
8. Pressing the “Play” button will cause the recording to replay as if it was a live measurement, from time = 0 seconds. During this replay, the live value of dPR is displayed in the bottom of the information window. Press the “Stop” button at any time during the replay to end it and return to the playback screen.
9. Pressing the “Live” button sends the screen back to the MAIN screen, where live measurements resume, and another recording can be initiated.
10. Press the “Pd/Pa” button to view the Pd/Pa pullback recording (see section 7.8.4).

- Pressing the dPR scale will override automatic scaling and scroll through different scale selections.

7.8.4 Viewing Pd/Pa Pullback in Playback Mode

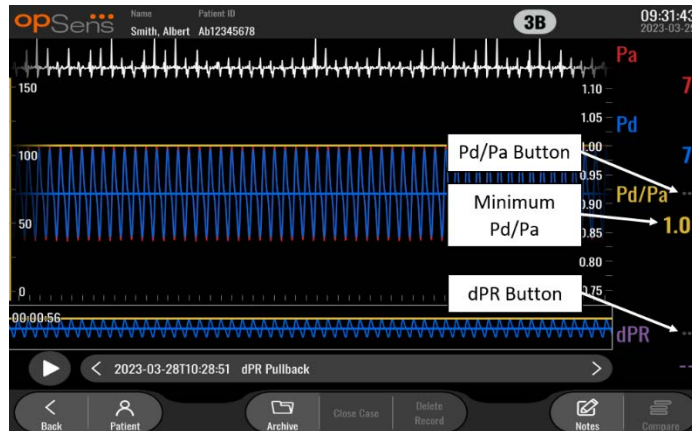

In the playback screen for a dPR pullback, press the Pd/Pa button to display the Pd/Pa pullback recordings. The Pd/Pa pullback playback mode has all of the same functionalities as dPR pullback playback mode, however Pa, Pd, and Pd/Pa are updated as the graph is manipulated while dPR is not shown.

To return to dPR pullback playback mode, simply press the dPR button.

7.9 Performing TAVI procedure

CAUTIONS:

Hemodynamics parameters such as Aortic Regurgitation Index alone cannot provide basis for clinical decision and their interpretation is left to physicians. Values should be interpreted by comparing pre- to post-procedural measurements, along with other information available such as imaging modalities.

*For definition and interpretation guidance of the ARi, refer to Figures 1 and 2 of Sinning JM et al. Aortic regurgitation index defines severity of peri-prosthetic regurgitation and predicts outcome in patients after transcatheter aortic valve implantation. *J Am Coll Cardiol* 2012;59:1134–41.

7.9.1 When to record

You can use the software to record and document at multiple time throughout the procedure.

7.9.2 Recording Pressure – TAVI

- Make sure the interface is set to TAVI and is not FFR. This can be changed in the settings menu or upon connection of a SavvyWire™ pressure guidewire.

2. For accurate measurements, equalize the pressure guidewire with the aortic transducer. The procedure is described in section 7.5.2.
3. From the MAIN screen, press the Record button on the Display Unit Screen to start recording pressure. (The OptoMonitor 3 can record sequences over a total recording period of 2 hours).
4. The recording starts when the button is pressed.

NOTE: Some values may take some time to appear. This is due to the averaging of the values over the selected number of beats. The pulse rate is averaged over a fixed number of beats and may take longer.

5. During recording, tap the graphic area twice to create a marker (solid white line). Before or during recording, you can press the values with the , to change the displayed values.
6. Press the “Stop” button to end the recording. The screen will switch to playback mode (see section 7.9.3 for a more detailed explanation of TAVI playback).
7. To make another recording, from the playback screen press the live button and press the record button.

7.9.3 Viewing TAVI in Playback Mode

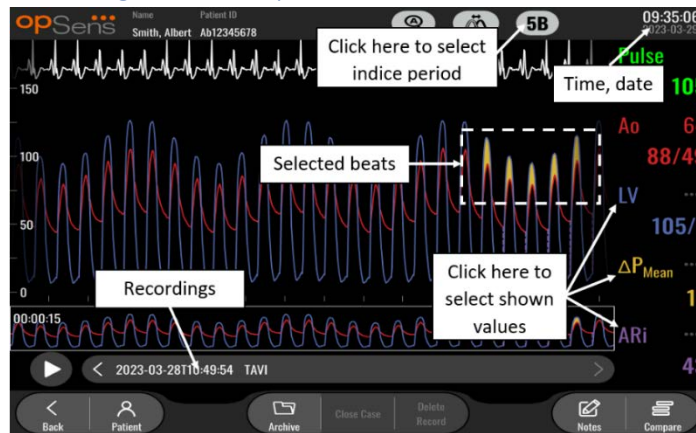

Upon completion of a TAVI recording, the screen will switch to playback mode where the user can see all the recorded data of the current patient. If you wish to access playback mode without performing a recording, press the “View” button from the MAIN screen.

All locally stored recordings for the current patient will appear in the recording selection box. If no case is open, all non-case recordings will appear in the selection box. The user can use their finger to scroll up/down to view all locally stored recordings and can tap a desired recording to load it into the graphical window and data window.

The user can use their finger to scroll/zoom to view specific sections of the recording and identify regions of interest.

The user can press on the signal to select the beats used to calculate the values on the right.

Pressing the “Play” button will cause the recording to replay as if it was a live measurement, from time = 0 seconds. During this replay, the live value of FFR is displayed in the bottom of the information window. Press the “Stop” button at any time during the replay to end it and return to the playback screen.

Pressing the values marked with  changes the displayed values alongside the recording.

Pression the “Select indices period” button will open a pop-up window, where user can view the averaging period and select the Indices Period.

NOTE: When saving recording to an USB key or via DICOM through the Archive Menu, ensure to select the desired beats, gradients, and indices on the DU in the Playback mode so that the right values are shown.

7.9.4 Select indices period

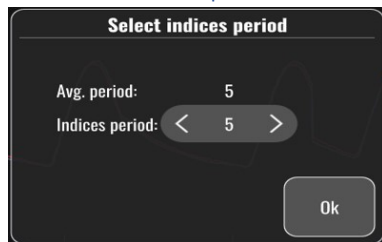

In TAVI, this represents the number of beats used to calculate gradients, regurgitation indices and LVEDP. This will change the number of beats selected in playback. The pulse rate, systolic, diastolic, and mean pressure are not affected by this setting.

7.9.5 Select pressure wire delay



1. The Pressure wire delay can be adjusted by pressing the “<” arrow or the “>” arrow. It can automatically be adjusted by pressing the “Auto” button.
2. The Reset button allows you to return to the original delay value during recording.

7.9.6 Compare/View screen

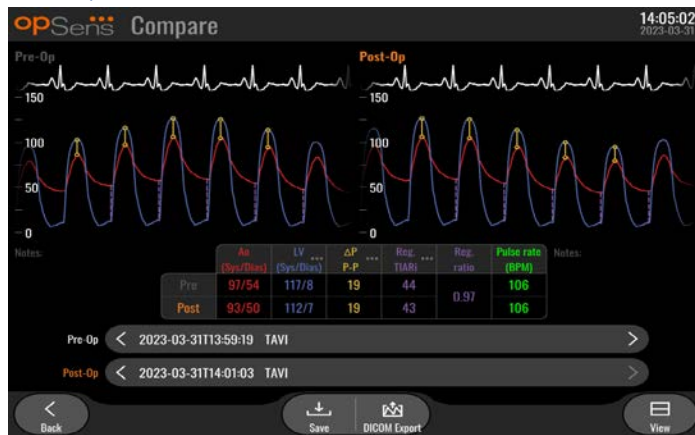

In playback, when viewing a TAVI recording, the compare and view screens are available. The screen highlights the differences between two recordings. In the table, the button  can be pressed and change the gradients or regurgitation indices shown. The save button records a screenshot of the current view which can be exported on an USB drive. When available, the DICOM export button takes a screen capture which is sent to the PACS.

The View screen shows the same information and capabilities, but the layout is different. The removal of the file selector allows more space to display the signal and the save and DICOM Export buttons are available.

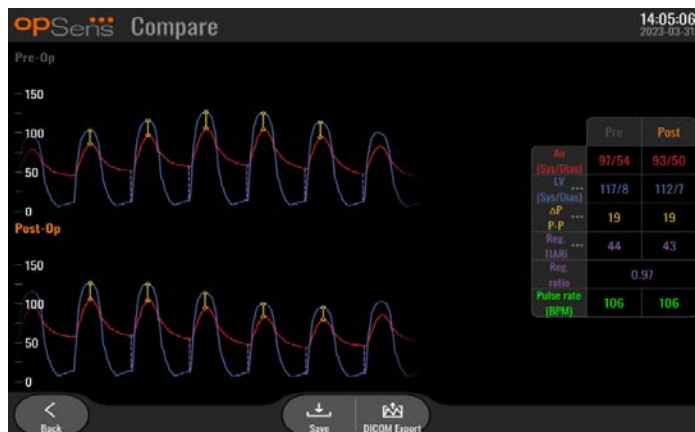

7.9.7 Playback Gradients and regurgitation indicators

For TAVI recordings, the OptoMonitor 3 Display Unit can detect specific features in the signal which is then used to calculate gradients and regurgitation indices. The physician can then validate if the detection was made correctly before using the values.

- **LVEDP:** The left-ventricular end of diastolic position is used in the regurgitation indices. The detected position is shown with a vertical dotted line between Ao and LV.

- **Gradient Instantaneous** ΔP_{Inst} : This is the maximum pressure difference found between LV and Ao when the valve is open. This is shown using a full vertical line at the maximum pressure position and circles at the used pressures.
- **Gradient Peak to peak** ΔP_{P-P} : This is the difference in pressure found between LV and Ao systolic values. The indicator is in the middle between the LV and Ao peak position and the circles are located at the peak values.
- **Gradient Mean** ΔP_{Mean} : This is the mean pressure difference found between LV and Ao when the valve is open. The indicator is a highlighted area between LV and Ao.

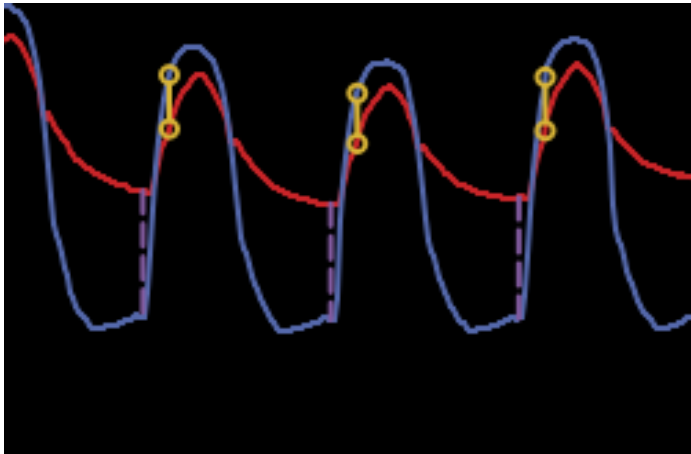

Instantaneous gradient and LVEDP positions are shown

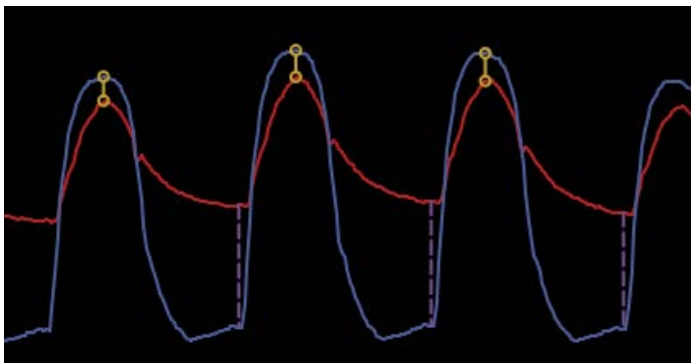

Peak to peak gradient and LVEDP positions are shown

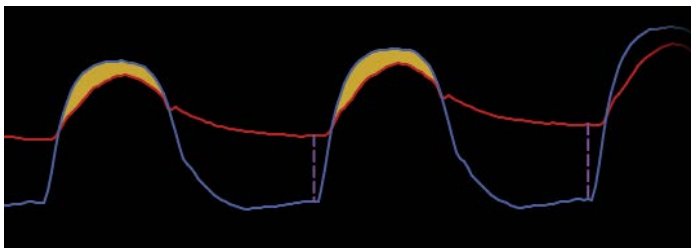

Mean gradient and LVEDP positions are shown

7.10 Playback functions

All forms of recording playback have the same four function buttons available: Patient, Segments, USB Export, and DICOM Export. Each button works identical regardless of which form of playback mode the system is in.





The “Patient” and “Segments” functions apply directly to the recording selected. Ensure that the desired recording has been selected. If it has not, use your finger to scroll up/down through the recordings list in the message window until you locate the desired recording, and tap it once to load the data.

7.10.1 Creating or Updating Patient Information

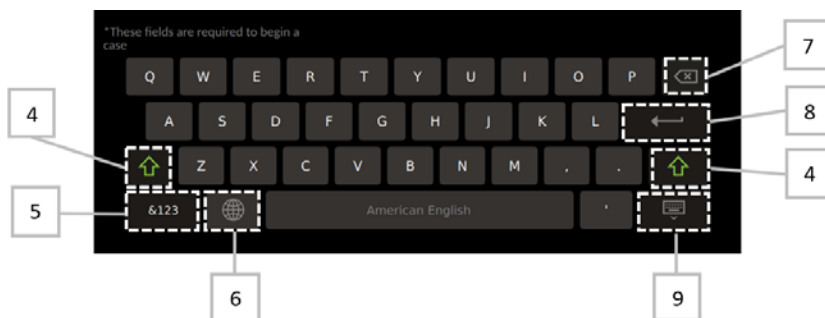
The screenshot shows the 'Patient Information' form in the OP Sens application. The form is organized into several rows of input fields. The top row contains 'Last Name', 'First Name', and 'Performing Physician'. The second row contains 'Middle Name', 'Patient ID*', 'Gender' (with left and right arrow buttons), and 'Study Description'. The third row contains 'Date of Birth (YYYY-MM-DD)', 'Procedure Date (YYYY-MM-DD)' (pre-filled with '2023 - 03 - 10'), and 'Accession Number'. A note below the form states '*This field is required to begin a case'. A warning icon indicates 'Fields must not include following characters < > : / \ | ? *'. At the bottom, there are three buttons: 'Back', 'Clear info', and 'DICOM list'. The top right corner shows the time '10:26:11' and date '2023-03-10'.

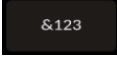
1. From the MAIN screen, press the “Patient” button. (Pressing the “Patient” button from the play back screen will allow the user to view the patient information but will not allow the user to input or alter any patient information).
2. The user can input patient information by tapping the desired patient field and keying in the characters on the keypad that appears. Fields include last name of patient, middle name of patient, first name of patient, gender of patient, patient ID number, date of patient’s birth, date of procedure, accession number, the name of performing physician, and any description relevant to the procedure/study. The marked fields are required to begin a new case.

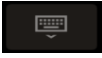

3. If there is already text in the field, the user can tap on the text box to move the cursor to a desired location, where they can add or delete characters.
 4. Use the green arrow key  on either the left or right side of the keypad to apply/remove shift key functionality.
 5. Use the  button in the bottom left of the keypad to access numbers and special symbols. Pressing the “ABC” button in the same location when the keypad is in numerical/symbol mode returns the pad to alphabetical.
 6. Press the globe  on the bottom row, second from the left on the keypad to change keypad language. Select the desired language from the dropdown menu that appears.
 7. Press the backspace  in the top right of the keypad to delete the symbol to the left of the cursor.
 8. Press the enter  in the second row along the right side of the keypad to enter the text into the field and remove the keypad.
 9. Press the keypad  on the bottom row along the right side of the keypad to hide the keypad.
- To clear all entries from the patient, press the “Clear Info” button located near the middle of the screen.
 - To access the list of stored patient ID’s via DICOM uplink, press the “DICOM List” button located near the middle of the screen (see section 6.1.2).
 - To confirm changes made to patient information, press the green arrow button at the bottom right corner of the screen.
 - See section [6](#) for more information regarding management of patient data.

7.10.2 FFR/dPR Notes

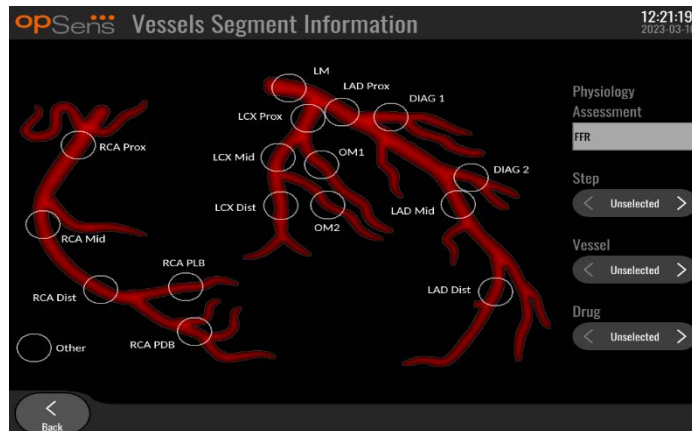

The OptoMonitor 3 system can store vital information regarding vessel segments of individual patients. This information can be updated at any point during the procedure and can be passed along in USB or DICOM exports.

1. Physiology assessment is automatically updated based on the type of recording performed.
2. The user can identify what step of the procedure this recording is related to (e.g., pre or post-PCI).

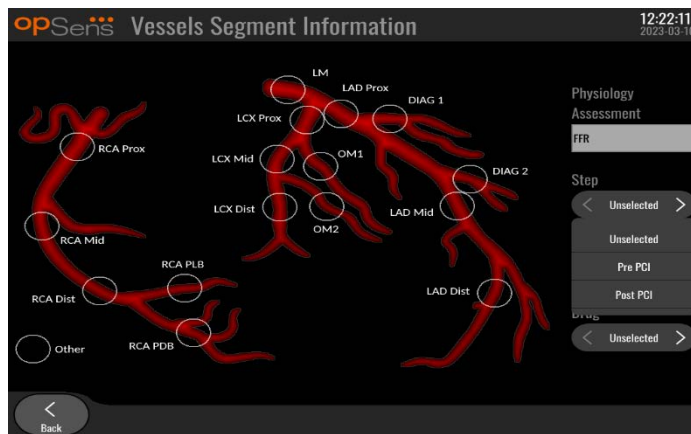

3. The user can identify the particular vessel this recording is related to. The user can choose the vessel from the drop-down list or alternatively select the corresponding vessel in the vessels diagram by pressing the appropriate circle.

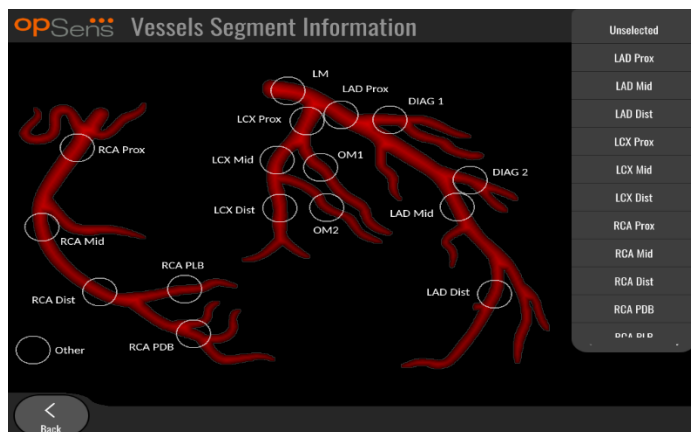

4. The user can identify which drug was administered during the procedure.

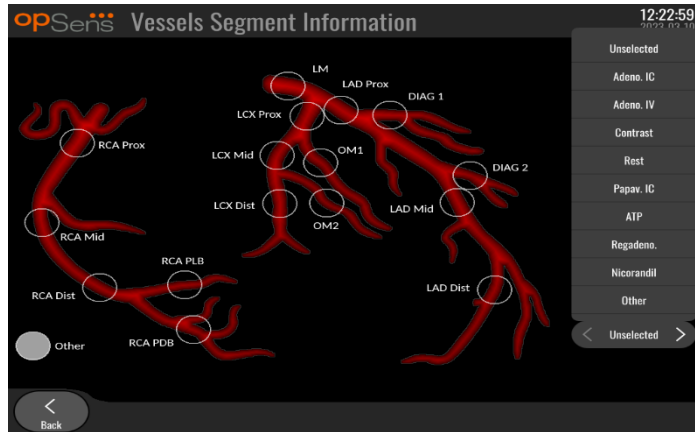

5. To confirm changes to the vessel segment information, exit the screen with the back button.

7.10.3 TAVI Notes

The OptoMonitor 3 system can store information alongside the recordings. This information can be updated at any point during the procedure and can be passed along in USB or DICOM exports.

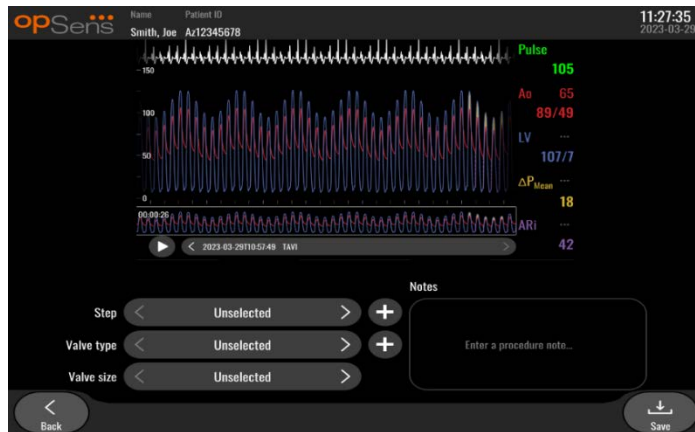

1. The user can identify the procedure step associated to the recording. The user can choose the step from the drop-down list.

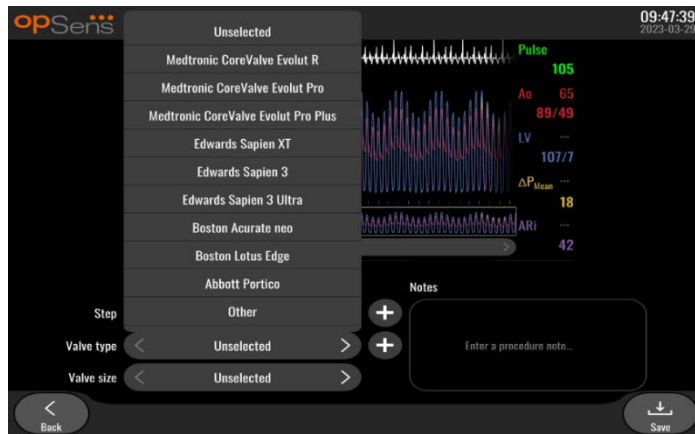

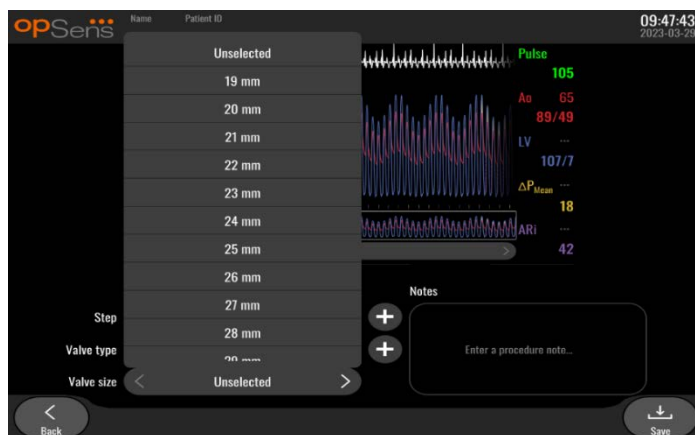
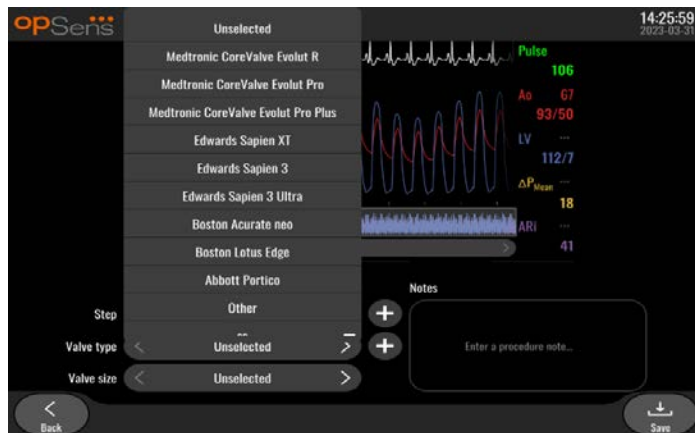

2. The user can identify the valve and valve size used during the procedure.



3. Text notes can also be saved alongside the recordings.



- The  button allows the creation of custom valve types and procedure steps. These can be deleted by using the  button in the drop-down list.

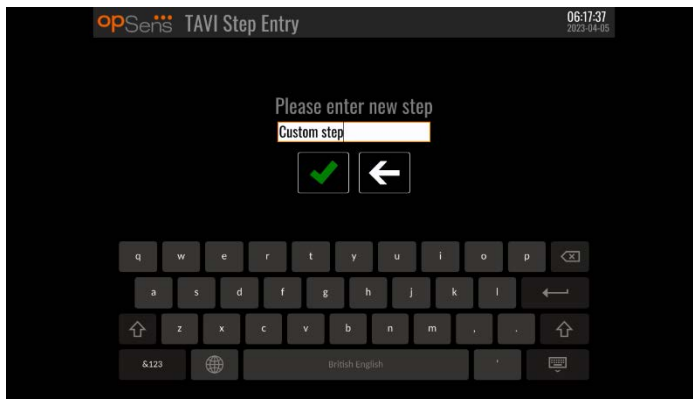

7.10.4 Reviewing Data

Use the "Play" button to load curves and review the data.

7.10.5 Archiving and deleting data

7.10.5.1 Saving Pressure Data to a USB Drive

1. Insert a USB 3.0 drive into one of the USB ports along the bottom of the device.

NOTE: You may need to unscrew the protective panel along the bottom of the device to insert the drive.

2. From the Archive screen, select patient and press the “USB Export” button to begin an upload of the data to the USB drive.
3. To save data without patient information, press the “Anonymous Export” button. This will upload an anonymous version of the data.

7.10.5.2 Uploading Procedures Data via DICOM Export

If the OptoMonitor 3 system is properly linked to the facility’s RIS and PACS, you can export procedures data via DICOM:

1. From the MAIN screen, press the “Patient” button to access patient information.
2. Press the “DICOM List” button and select the patient whose data will be used for the case (see section 6.1.2). Alternatively, manually enter patient information, filling the required fields to begin a case. Press the back button to save patient information and return to the MAIN screen.
3. Perform one or multiple FFR, dPR, or dPR Pullback recording(s).
4. After the desired recordings have been produced, press the “DICOM Export” button in the playback screen. Pressing this causes the system to send a screenshot of all the previously un-exported recordings, capturing all relevant graphical and numerical data for the recordings along with procedure-specific data such as the FFR or dPR value. The images are then sent via DICOM to the PACS and is now available for viewing/storing in patient data in the PACS. If a recording’s data were to be modified by the user (e.g., the cursor position, the vessel, drug, or step selection, the zoom value etc.), the affected recording’s status of exportation will be reset and its data will be resent to the PACS if the “DICOM Export” button is pressed again.

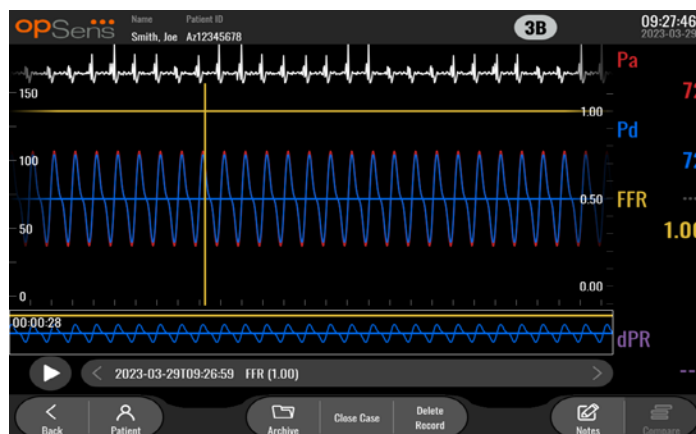

7.10.5.3 Deleting Procedures

To delete a recording, scroll up/down through the list of recording(s) and select the desired recording. Press the “Del. Record” button.

To delete all recording from one patient, hit the “Archive” button, select the patient for which all recordings must be deleted and hit the “Delete” button.

To delete all locally stored files from the DU, hit the “Archive” button, then hit “select all” and “Delete” button.

7.10.5.4 Storage Space

Hit “Archive” button and “Storage Space” to view storage space on the DU.

This will display two diagrams. The first one indicated the internal storage space. The second one indicated the storage space on the USB drive.



7.11 Terminate Operation

Once procedure is completed, unit can be left turned on. Optional screen lock will activate after specified delay. It is possible to turn unit OFF by pressing the power button on the Optical Unit for approximately 5 consecutive seconds. The Display Unit can be turned off using the power button located under the unit.

8 MAINTENANCE

Qualified service personnel should perform the following regular maintenance every 12 months to ensure OptoMonitor 3 optimal performance.

The OptoMonitor 3 has a Maintenance menu where service personnel can verify the system performance status and ensure the system functions according to the manufacturing specifications.

The Maintenance Menu gives access to the following parameters adjustments and factory settings.

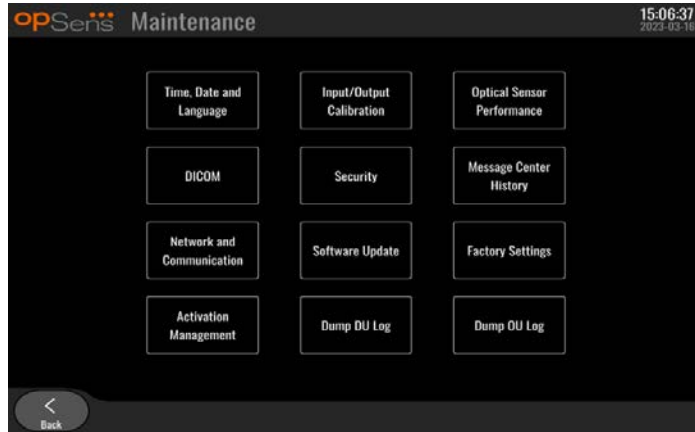

8.1 Accessing the Maintenance Menu

1. Press the SETTINGS button from the MAIN screen.



2. In the settings screen, press the “Maintenance” button.
3. Enter the access code when prompted, click ✓ to continue. Refer to section 8.12 for default values.

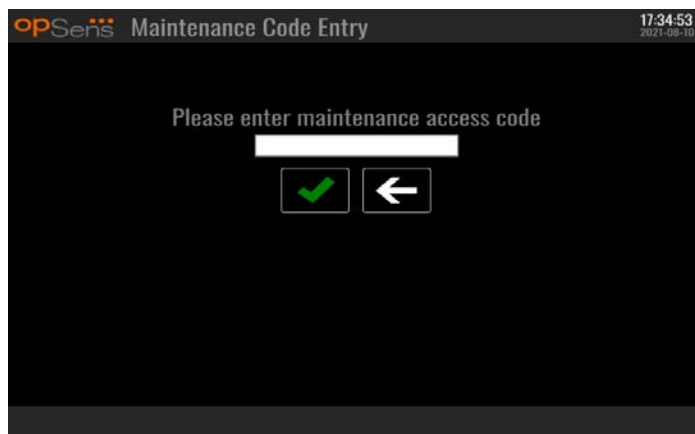

8.2 Adjusting the Time, Date, and Language

From the maintenance screen, press the “Time, Date, and Language” button located in the left-top portion of the grid.

Set the time by pressing the buttons above/below the digital clock in the left side of the screen. Note that this clock operates as a 24-hour clock.

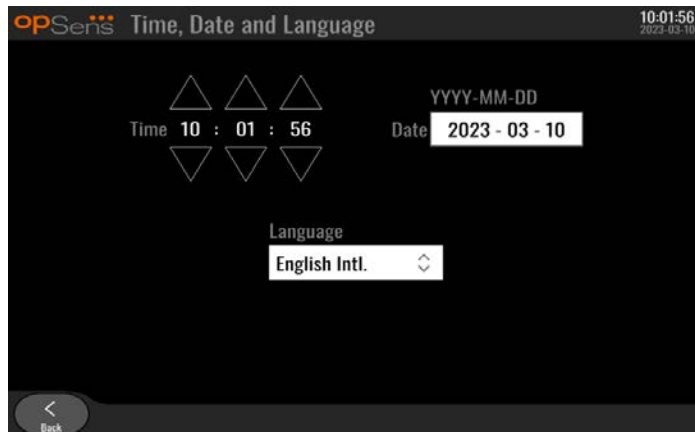

To set the date, press the date text box. This will cause a numerical pad to appear at the bottom of the screen.



In the format of year-month-day, type in the corresponding numerical date. By tapping on the text box, you can select a specific number to delete. For information regarding specific keypad symbols, refer to section 7.10.1.

To set the language, press the “Language” button, and select the desired language from the drop-down menu.

8.3 Input/output Calibration with Cathlab Hemodynamic System

From the maintenance screen, press the “Input/Output Calibration” button located in the middle-top portion of the grid.

8.3.1 Calibrating Aortic Input Reference to Aortic Transducer

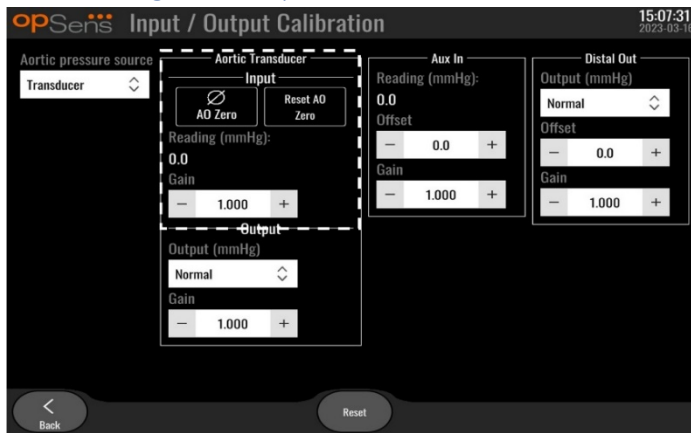

Aortic Transducer Input calibration is detailed in section 18.

8.3.2 Calibrating Aux Input Reference to Cathlab Hemodynamic System

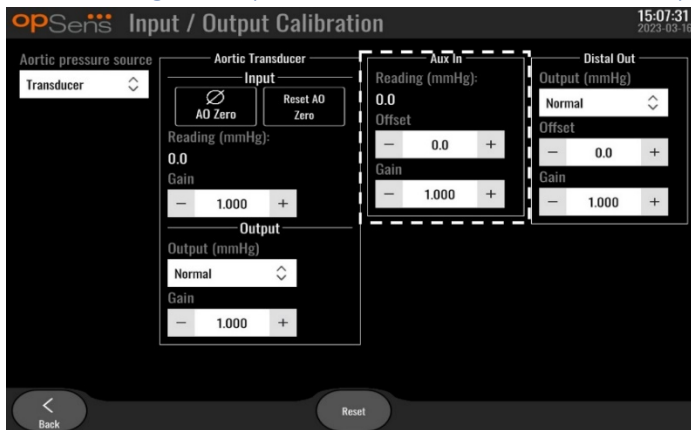

Step-by-step AUX In (Aortic input from Cathlab Hemodynamic System) calibration is detailed in section 17.

8.3.3 Calibrating Distal Output to Cathlab Hemodynamic System

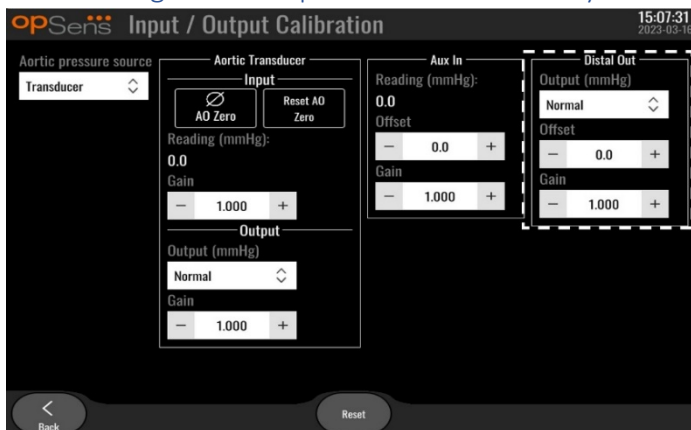

Step-by-step Distal Output calibration is detailed in section [19](#).

8.3.4 Calibrating Aortic Output to Cathlab System

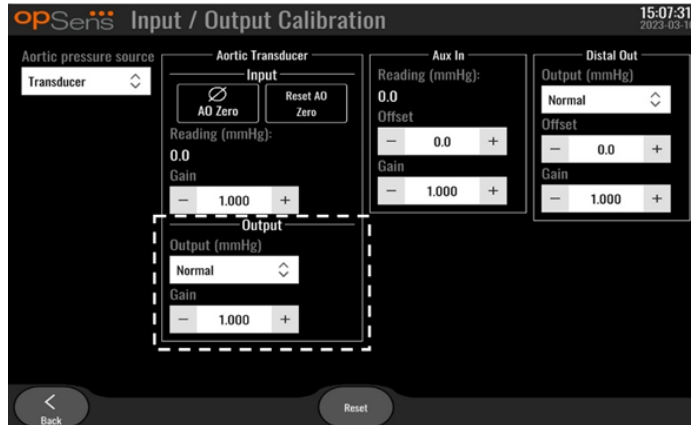

Step-by-step Aortic Output calibration is detailed in section 20.

8.4 Reviewing Optical Sensor Performance

From the maintenance screen, press the “Optical Sensor Performance” menu. This menu displays readings and data relevant to the performance of the pressure guidewire currently being used. If no wire is plugged into the OpM3, if the pressure guidewire is malfunctioning, or if it is not correctly plugged into the OpM3, then no data will appear on this screen. Once a functioning pressure wire is connected to the OpM3 system, this screen will populate with live data relating to the performance of the wire (image below). This screen displays the guidewire’s Serial Number, probe value in nanometers, plus the actual value in nanometers read by the Optical Unit and the difference between the two (Delta).

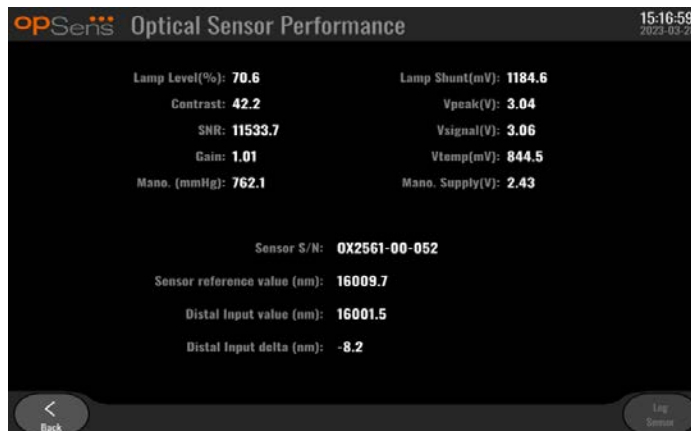

A “Log Sensor” button is available when the optical unit (OU) has a version higher than 4.1.7.

The “Log sensor” button can be used so that the optical sensor performance information is added in the OU logs.

It is also possible to plug a Reference probe or a Reference Gauge factor to obtain reference values. If the pressure guidewire presents poor signal values, it may need replacing. If the replacement wire also presents poor signal values, contact authorized field service person and/or OpSens.

Diagnostic value: Parameter	Descriptions	Typical signal with Reference Probe	Poor signal
Lamp Level (%)	Lamp driving level	70%	
Contrast (%)	Optical signal contrast visibility level	50 %	< 35 %
SNR	Signal to noise ratio	> 4000	< 2000
Gain	Signal Maximal Amplitude	1.7	> 2.2

CAUTION:

- As part of the hospital’s maintenance program, routine safe inspection and testing should be conducted annually. Trained hospital technicians should inspect and test all isolated connections and the system power supply.
- The OpSens OptoMonitor has no user-serviceable parts. Please refer any servicing to authorised service personnel or to OpSens directly.

Mano. (mmHg): Check and validate that the OptoMonitor manometer reads the correct value. Read the atmospheric pressure and compare it with the OptoMonitor manometer reading. Contact OpSens authorized field service person and/or OpSens should the difference in reading exceeds 10 mmHg.

Distal Input delta (nm): This value should not be less than ± 8 nanometers.

8.5 Testing DICOM

From the maintenance screen, press the “DICOM” button located in the middle-left portion of the grid.

Displays general information regarding the connection between OpM3 and DICOM uplink. Qualified personnel may use this screen to test the status of the OpM3 and DICOM connection.

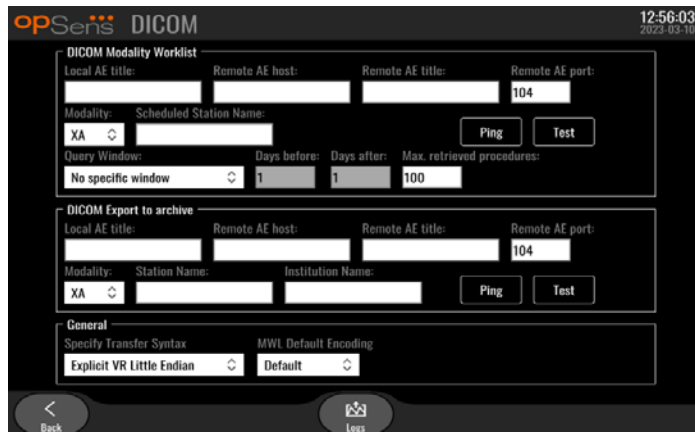

8.5.1 Testing DICOM

There is two ways of testing the connexion to the DICOM server:

1. Use the ping button to check if the DU can detect the DICOM server.
2. Use the test button to check if the DICOM server can send information to the DU.

8.5.2 Filtering the Modality Worklist

If no information is entered in the Schedules Stations Name, and “No specific window” in the Query Window, then all procedures from the Modality Worklist will be displayed, in a limit of 100 procedures. However, it is possible to filter down the list of displayed procedures within the DICOM Modality Worklist.

In the Modality drop-down menu, it is possible to filter by modality:

- **XA:** X-Ray Angiography.
- **OT:** Other.
- **CT:** Computed Tomography.

It is also possible to filter by Scheduled Station Name. The Scheduled Station Name must be entered manually.

In the Query Window drop-down menu, it is possible to filter down the list by a time frame:

- **No specific Window:** In this case, no time filter is applied.
- **Schedules for today:** Only procedures that are scheduled for today will be displayed.
- **Specify around current date:** Only procedures that are scheduled within the range [Days before; Days After] will be displayed.
- **Max. Retrieved Procedures:** This is the max number of procedures that will be displayed in the worklist. The maximal possible value is 100. It is also the default value.

8.5.3 Display information on the Exported Images

Within the DICOM Export to archive section, the Modality (XA, OT or CT), the Station Name and the Institution Name can be entered manually and will be displayed on the exported images. If no information is entered, no information will be added to the exported images.

8.6 Security

From the maintenance screen, press the “Security” button located in the center of the grid.

8.6.1 Setting up a Startup Password

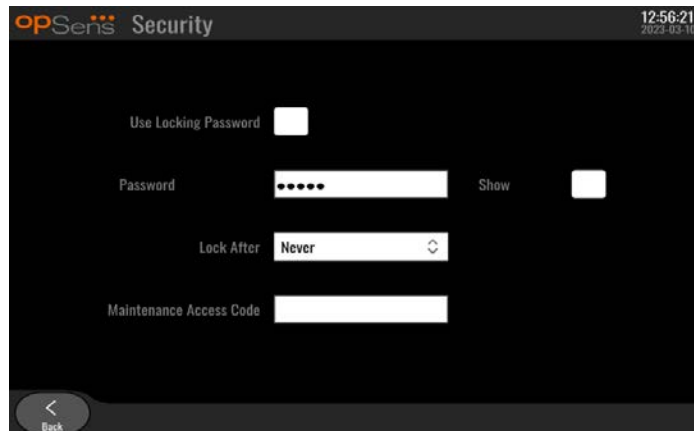

1. If no startup password was previously required, tap the box so that it is now required.
2. Tap the “Password” textbox to bring up a keypad. If a password was used previously, you may delete it by pressing the backspace arrow on the keypad. Type in the new password using alphabetical characters, numerical, and symbols. To hide the password as you type, leave the “Show” box unchecked. To show the password as you type, check the “Show” box.
3. To cause the device to lock after a certain amount of inactivity, tap the “Lock After” field, and choose the desired time from the drop-down menu.
4. To save password/lock changes, exit the screen with the back button.

The device will now require a password to be entered in order to use it upon start up. If chosen, the device will also lock after a certain amount of time inactive, requiring a password upon restarting.

8.6.2 Changing the Maintenance Access Code

1. Tap the “Maintenance Access Code” textbox to bring up a keypad. If an access code has been used previously, you may delete it using the backspace arrow on the keypad. Type in the new access code using alphabetical characters, numerical, and symbols.
2. To save access code changes, exit the screen with the back button.

8.7 Reviewing Message History

From the maintenance screen, press the “Message Center History” button located in the middle-right side of the grid. The next screen will contain a list of all previous messages received from the OptoMonitor3, ordered by date of the message. Use your finger to scroll up/down through the list.

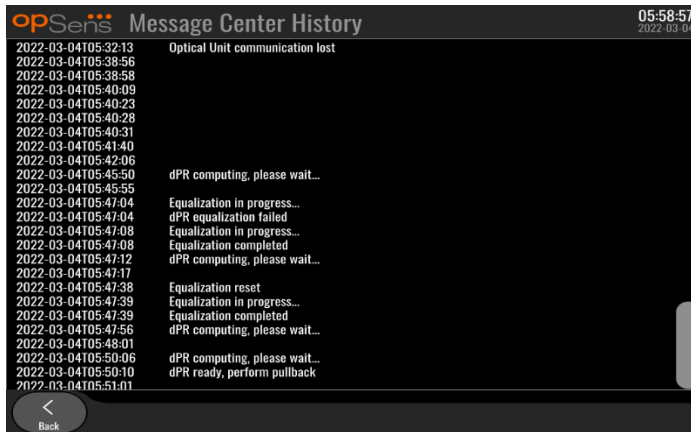

8.8 Reviewing Network and Communication

From the maintenance screen, press the “Network and Communication” button located in the bottom-left portion of the grid. This screen displays the MAC addresses, IP addresses, net mask, and gateway information regarding the LAN connections with the DU.

8.8.1 DU LAN1 connection to DICOM

LAN1 purpose is to query the patient list and transfer procedure results through DICOM.

The required characteristics of the IT network is to have an Ethernet LAN connectivity to an RIS and PACS server.

The configuration to the IT-Network must respect the DICOM standard of the hospital. RIS and PACS server shall be set-up with a fixed IPv4 address or a DNS shall be available to perform resolution of their hostnames.

To lower cyber-security risks, the IT-network should be confined to the healthcare facility (not connected to the Internet).

The intended information flow is: PEMS – (MWL Request)--> RIS – (Patient List)--> PEMS – (Procedure Results)--> PACS

8.8.2 DU-15” LAN2 connection to the Optical unit

LAN2 is reserved for communication between the DU and the OU. To select how the OU and DU communicate with one another, press the “OU/DU Communication Link” textbox and select the “LAN” option, depending on your desired communication method.

8.8.3 Wireless

This screen also allows for the connection and management of wireless devices with the DU. To set up wireless connection, the DU and the OU must first be connected using the communication cable (LAN for DU-15" or Serial for DU-10").

Once the connexion is established with the communication cable, the following settings will allow a wireless connection:

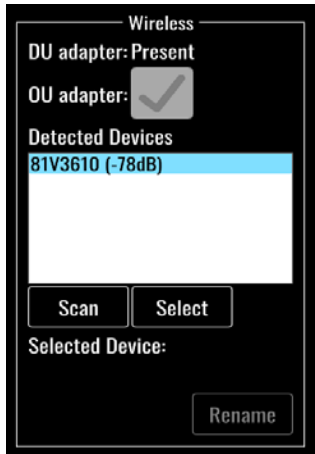

DU adapter indicates if the wireless dongle is detected or not. “Not detected” indicates that the dongle is not connected. “Present” indicates that the dongle is connected.

OU adapter allows user to deactivate the wireless module within the OU. This must be selected for a successful wireless connection.

To insure a successful wireless connection, the wireless dongle must be connected to the DU via one of the USB ports, DU adapter must indicate present and OU adapter must be selected.

The “Scan” button will display all compatible wireless devices that may be connected to the DU. The strength of the signal is displayed in brackets.

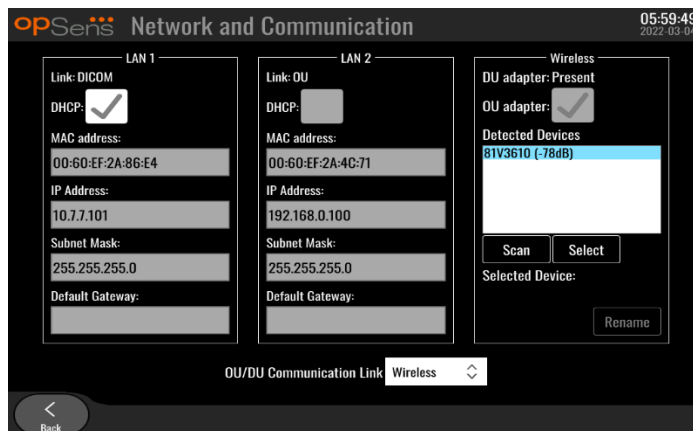

You may select the desired device to connect to the DU by selecting the desired device and pressing the “Select” button at the bottom of the box.

Finally, select “Wireless” in the OU/DU Communication Link box and press the back button to save the selection.



When going back to main screen, you should see the following icon in the top right hand corner :



Wireless connexion is successful. If this is the case, the communication cable (LAN for DU-15" or Serial for DU-10") may be removed. At least 2 out of 4 bars must be green for the signal to be acceptable.



OU/DU Communication Link is « Wireless » and DU adapter is detected, but wireless connexion is unsuccessful. In this case, check the OU is in reach and the level of the signal is good.



OU/DU Communication Link is « Wireless » but DU adapter is not detected, therefore wireless connexion is unsuccessful.

There is a direct correlation between the signal strength in dB in the Network and Communication section and the signal strength displayed on the Main Screen.

No bars: Connexion is unlikely.

1 bar: Connexion is weak.

2 bars: Connexion is good.

3 bars: Connexion is strong.

4 bars: Connexion is excellent.

8.9 Software Update for Display Unit or Optical Unit

From the maintenance screen, press the “Software Update” button located in the bottom-middle portion of the grid.

The OptoMonitor 3 Optical Unit and Display Unit firmware can be updated by using a USB key containing the required software files. Both the Optical Unit and Display Unit are updated one at a time. The procedure to update either the OU or the DU is the same, however each has its own unique “Update Software” button.

A wired connection is required between DU and OU to update the OU (it can not be wireless during the update).

1. Insert the USB key into the connector.

NOTE: May require removal of the protective panel along the bottom of the device to gain access to the USB port.

2. On the DU screen, press the SETTINGS button.
3. Press the MAINTENANCE button.
4. Enter the Maintenance Access Code and confirm.
5. Press the SOFTWARE UPDATE button; the “Connected” status appears beside the “USB Drive” field.
6. Press the “Update Software” button in the appropriate section to update the DU or the OU. The update process will then begin if a valid update file was found on the USB drive.

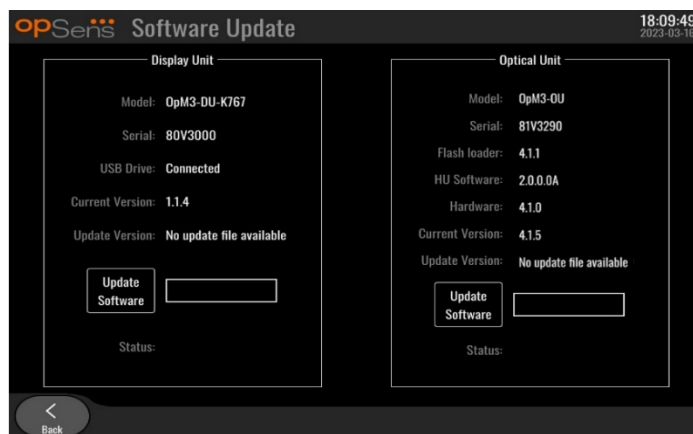

8.10 Factory Settings

The Factory button is reserved for Manufacturer internal use.

8.11 DUMP Logs

The dump logs contain messages concerning the DU or OU history.

To export the logs, insert an USB drive in the DU and navigate to the Maintenance window.

Press “DUMP DU Log” button to save DU logs to the USB drive.

Press “DUMP OU Log” button to save OU logs to the USB drive.

In both cases, a text file will be saved on the USB key. This text files contains all the logs and gives insight on the history of the DU or OU operations. This can help troubleshooting. Once the message “Done!” appears in the pop-up message, the dump is completed, and the USB drive may be removed.



The message can also be:

“Make sure the OU is connected”: The OU and DU must be connected to dump the OU logs. The connection can be wireless or via the cable.

“Make sure USB drive is connected”: A USB drive must be inserted in the DU (or through the USB extension cable) to dump the logs.

8.12 Adjustable settings

The following table shows the various adjustable settings with their ranges and default values.

8.12.1 SETTINGS MENU

Setting	Range	Default
Pressure scale	0-250, 0-200, 0-150, 0-100, -50-300, -100-200	0-200
Time scale	3, 6, 15, 30	3
dPR enabled	Enabled, Disabled	Disabled
Prospective Equalization	Enabled, Disabled	Disabled
Averaging period	1, 2, 3, 4, 5	3
Pullback time scale	30, 45, 60, 75	45
Hide Patient Info	Enabled, Disabled	Disabled
Pressure Wire Delay	0-1000	0
Show ECG	Enabled, Disabled	Disabled
TAVI Averaging period	1, 2, 3, 4, 5, 6, 7, 8, 9, 10	5
FFR/TAVI	FFR or TAVI	FFR

8.12.2 MAINTENANCE MENU Input/Output Calibration

Setting	Range	Default
PA Source	Transducer, AUX	AUX
Aortic Transducer Input – Gain	0.5-2.0	1.0

Aortic Transducer Output – Output	0, 50, 100, 200, 300, -30, Normal, 0-100, 0-200, 0-300, -30-300	Normal
Aortic Transducer Output – Gain	0.5-2.0	1.0
Aux Input – Offset	-10.0-10.0	0.0
Aux Input – Gain	0.5-2.0	1.0
Pd Out – Output	0, 50, 100, 200, 300, -30, Normal, 0-100, 0-200, 0-300, -30-300	Normal
Pd Out – Offset	-10.0-10.0	0.0
Pd Out– Gain	0.5-2.0	1.0

8.12.3 MAINTENANCE MENU Security

Setting	Range	Default
Use locking password	Enabled, Disabled	Enabled
Password	Alphabetical characters, numerical, and symbols	Ops22
Lock After	Never, 10 min, 30 min, 60 min	Never
Maintenance Access Code	Numerical	0750

8.12.4 MAINTENANCE MENU Network and Communication

Setting	Range	Default
LAN1 DHCP	Enabled, Disabled	Enabled
LAN1 MAC	Read-Only Value	<MAC address> for DICOM LAN
LAN1 Address	< IP address format>	<blank>
LAN1 Net Mask	< X.X.X.X>	<blank>
LAN1 Gateway	< X.X.X.X>	<blank>
LAN2 DHCP	Enabled, Disabled	Disabled
LAN2 MAC	Read-Only Value	<MAC address> for OU LAN
LAN2 Address	< IP address format>	192.168.0.100
LAN2 Net Mask	< X.X.X.X>	255.255.255.0
LAN2 Gateway	< X.X.X.X>	<blank>
OU adapter	Enabled, Disabled	Disabled
OU/DU Communication link	LAN, Wireless Serial, Wireless	LAN (DU-15") Serial (DU-10")
Wireless Enable	Enabled, Disabled	Enabled (if dongle is present), otherwise Disabled

9 FIELD SERVICE INFORMATION

To reduce the risk of electric shock, do not remove cover (or back). The OpSens OptoMonitor 3 has no user-serviceable parts. Please refer any servicing to authorized service personnel or to OpSens directly.

10 GENERAL CARE AND CLEANING

10.1 Cleaning

Keep your monitor, modules, cables, and accessories free of dust and dirt. Clean the exterior surface on a regular basis in compliance with your institution's infection control and biomedical engineering department.

After cleaning, check the equipment carefully. Do not use if you see signs of deterioration or damage.

WARNINGS:

- Disconnect all powered equipment from the power line before cleaning or disinfecting its surface.
- Do not disconnect other interface cables.
- If you spill liquid on the system or accessories, or they are accidentally immersed in liquid, contact your service personnel, OpSens or OpSens authorised service personnel. Do not operate the equipment before it has been tested and approved for further use.

CAUTIONS:

- Do not autoclave or steam clean the device.
- Do not immerse any part of the equipment or any accessories in liquid.
- Do not pour or spray any liquids directly on the device or permit fluid to seep into connections or openings.
- Do not use any abrasive material to scrub the instruments since this could cause damage to the system surface.
- Make sure that every part of the unit is dry before reconnecting to the power supply.
- Never use bleach. Do not use strong solvents such as acetone or trichloroethylene.

10.1.1 Optical Unit and Display Unit

The Optical Unit can be cleaned using standard disinfectants used in hospital environment such as a low-level disinfectant, solution of mild detergent and water, Isopropyl alcohol (70%) and any standard class cleaner (for Display Unit surface only). Cleaning products should be as close to neutral pH as possible.

- TURN OFF POWER to the Optical Unit but do not disconnect any interface cables.

- Wipe the exterior with a soft lint-free cloth, lightly moistened with the cleaning solution and wipe dry.
- Take extra care when cleaning the screen of the monitor because it is more sensitive to rough cleaning methods than the housing.
- Do not allow water or cleaning solution to enter the measurement connectors. Wipe around, not over, connector sockets.
- Turn power ON again.

10.1.2 Handle Unit



- TURN OFF POWER to the Optical Unit. Do not disconnect the Handle Unit cable from the Optical Unit.
- Place the dust cover on the opening of the Handle Unit.
- Lightly wipe the handle with gauze moistened with rubbing alcohol (70 % isopropyl alcohol).
- Do not allow water or cleaning solution to enter the opening connectors. Wipe around, not over, connector sockets.

10.1.3 Optical Connectors

All Fiber Optic Connectors on the OpM3 should be kept clean. Clean the proximal end of the male optical connectors with a dedicated fiber optic cleaner tool. Clean the inside of the female optical connectors with a dedicated fiber optic cleaner tool.

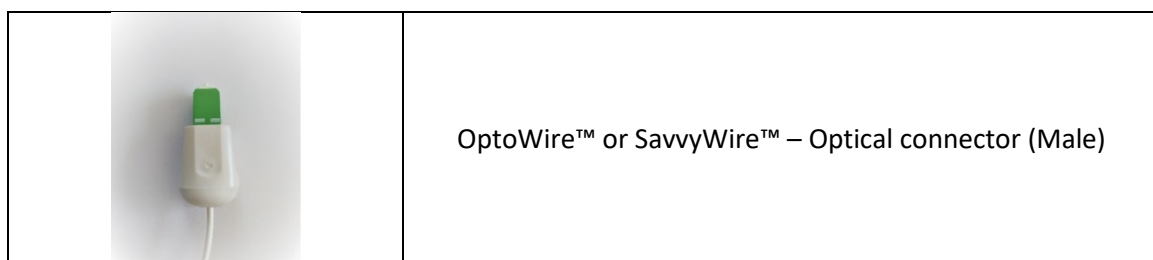
- The Handle Unit’s optical connector (female) should be cleaned before every new connection of a pressure guidewire.
- Both the Handle Unit’s optical connector (male) and the Optical Units’ optical connector (female) should be cleaned before being connected during installation.
- To keep the Handle Unit’s optical connector (male) and the Optical Units’ optical connector (female) clean, it is always recommended to keep them connected. Disconnect only when the unit needs replacing. In case of a disconnection, it is recommended to insert the Handle Unit’s dust cap protector. Only remove the cap when ready to connect the optical connectors again.
- Dust entering the connector(s) may reduce the optical signal quality and generate “No optical signal” warning messages.

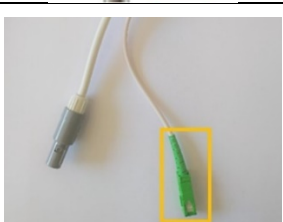
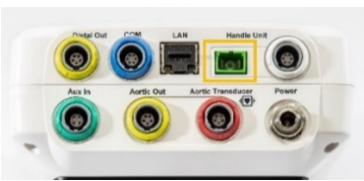

	<p>Handle Unit – Optical connector (Female)</p>
	<p>Handle Unit - Cap</p>
	<p>Handle Unit – Optical connector (Male)</p>
	<p>Optical Unit – Female Optical Connector</p>

10.2 Leakage Current Measurement

The OptoMonitor 3 is a fiber optic platform-based system. Perform measurement of device leakage current per hospital standard procedure.

10.3 Visual Inspection

10.3.1 General Routine Inspection

You should perform a visual inspection before every use, or in accordance with your hospital's policy.

With the OptoMonitor 3 switched off:

- Examine unit exteriors for cleanliness and general physical condition. Make sure that the housings are not cracked or broken, that everything is present, that there are no spilled liquids and that there are no signs of abuse.

- Make sure all cables connected to the OptoMonitor 3 are locked into place and do not pull out without releasing the locking mechanism.
- Inspect all accessories (cables, pressure guidewire and so forth). If any signs of damage are observed, do not use.
- Inspect all cables and their strain reliefs for general condition. Make sure there are no breaks in the insulation. Make sure that the connectors are properly engaged at each end to prevent rotation or other strain.

10.3.2 Annual Visual Inspection

The OptoMonitor 3 and its components should be carefully inspected once every 12 months.

- Carefully inspect the equipment for physical damage to the case, the display screen, and the keypad. Do not use the OptoMonitor 3 if damage is determined. Refer damaged equipment to qualified service personnel.
- Inspect all external connections for loose connectors or frayed cables. Have any damaged connectors or cables replaced by qualified service personnel.
- Inspect the Display Unit screen for marks, scratches, or other damage. Have the Display Unit repaired by qualified service personnel.
- Safety labels and inscription on the device are clearly legible.

10.4 Disposal

Pressure guidewire, clock battery and electronic equipment shall be handled and disposed of in accordance with local, state, and federal laws and regulations.

It is hospital responsibility to ensure proper decommissioning process is followed with regard to patient information stored on device.

11 TROUBLESHOOTING

11.1 Verify the Connection of the pressure guidewire

By default, the pressure guidewire is delivered pre-connected to the FOIC.

Message:

No signal, check OptoWire connection

or

No signal, check SavvyWire connection

or

No signal, check connection

The Display Unit prompts this message when the wire is not connected to the FOIC or the proper optical connection is not established.

NOTE: The OptoMonitor 3 audio alert plays two different tones for optical connection event.

- 2 Low tones – Lost connection of wire/ Optical disconnection occurred.
- 2 High tones – Successful connection of wire/ Optical connection occurred.

If Optical disconnection occurred:

1. Unlock the Handle locking mechanism and gently remove the pressure guidewire from its handle.
2. Gently reinsert the pressure guidewire into its handle and rotate the locking mechanism to the locked position.

11.2 Zeroing Failed

The zero cannot be performed if pressure is varying (such as pulsatile blood pressure).

When the zero fails, the message “**Zero aborted**” appears on the Message window.

1. Ensure wire is out of the patient.
2. In the SETTINGS screen, press the “OW Zero” button to perform a manual zero of the wire.
3. If the pressure is stable (outside the patient) and the message persists, check all connections.
4. If the message persists after verifying all connections, replace wire.

11.3 Wire Zeroed Twice

The message “**Zero aborted, old value used**” is displayed when the wire has been zeroed once before, and a zero value is stored in the memory. The wire is functional as intended.

NOTE: The OpSens pressure guidewires are intended for single use.

11.4 Aortic Input Zeroing Failed

The transducer Pa Input zero cannot be performed under the following circumstances:

- Pressure is varying (such as pulsatile blood pressure).
- The difference between the transducer Ao value and the Display Unit Pa value is ± 200 mmHg.

If the Pa Zero failed, in the case where zero has not been performed on Pa, the message “**Aortic zero failed!**” is shown.

In the case where Pa has been zeroed once, and a zero value is stored in the memory, the message “**Aortic zero failed, old value used**”.

Ensure aortic stopcock is open to air.

1. Ensure all connections are properly established.
2. Press the Ao Zero button to initiate the Pa zero.

11.5 Equalization Failed

“No Pd signal detected”

Equalization will not be performed because Pd signal isn't detected. Check connections between pressure guide wire, Handle-Unit, Optical-Unit and Display-Unit. Make sure both OU and DU are powered-on.

“No Pa signal detected”

Equalization will not be performed because Pa signal isn't detected. Check connections between Pa Source (can be transducer or Aux), Optical-Unit and Display-Unit. Make sure both OU and DU are powered-on.

“Communication error with Optical Unit. Please check Wireless Signal Strength or Physical Connection”

Equalization will not be performed because there is a poor or no connection between the Optical-Unit and the Display-Unit. Check cable connections and signal strength if Optical-Unit and Display-Unit are connected via wireless.

“Pressure average difference is out of limit. Please check setup and make sure live pressure”

Equalization will not be performed because there is a difference of at least twice the value between aortic and distal pressures. This means the equalization factor isn't between 0.48 and 2.08.

“Cannot compute dPR. Please make sure live pressure curves are valid and aligned.”

After a first attempt to equalize, if the equalization factor or dPR factor can't be applied to the OU, the software will automatically try to equalize a second time. After trying two unsuccessful equalizations in a row, this message will be displayed, and equalization will not be performed because the pressure curves are not good enough quality (pressure damping, contrast agent, etc.) or have an unexpected shape.

“Equalization not completed.”

If this message appears on the screen, contact OpSens for troubleshooting steps.

11.6 Pressure Wire Delay messages

“Please make sure live pressure curves are valid and aligned.”

This is a warning message. It tells the user that the time delay between Pa and Pd could either not be computed or the computed value is over limit. In both cases, it is to the user's discretion to adjust the *Pressure wire delay (ms)* setting, or not.

This message does not prevent equalization.

11.7 Re-Equalized

Equalization is normally performed only once at the beginning of the FFR or dPR assessment. Should a new equalization be initiated by pressing the Equalizing button, the message **“Equalization already done - Re-Equalize?”** pops up to warn from an eventually unwanted equalization. Press Yes to confirm, No to cancel, and Reset to reset equalization and restore Pd pressure to default value. To avoid an extra step after an eventual restart, the equalization factor is NOT reset when the instrument is restarted. The equalization parameters are kept in the non-volatile memory of the Gauge Factor Connector or of the pressure guidewire depending on which version of the pressure guidewire is being used.



“Old Equalization factor is invalid.”

This message could appear if the old factor saved is invalid or corrupted. User needs to re-equalize.

11.8 GFC and OptoWire™ Mismatch

Certain generations of OptoWire are delivered with a Gauge Factor Connector. The OptoWire can only be matched with the Gauge Factor Connector supplied in the same package. Both must be inserted into the Handle Unit to allow operation.

Should a discrepancy be detected by the system, the AMBER LEDs on the Handle Unit will start flashing.



The OptoMonitor 3 audio alert sounds 3 Medium tones.



A message **“Mismatch between OptoWire and GF connector”** is displayed on the Message Window.

12 SPECIFICATIONS

12.1 Technical Specifications

Pressure

Pressure range*	-30 to 300 mmHg			
Accuracy*	± 1 mmHg plus ± 1 % of reading (over the pressure range -30 to 50 mmHg) ± 3 % of reading (over the range 50 to 300 mmHg)			
Temperature zero sensitivity*	< 0.3 mmHg/°C			
Temperature gain sensitivity*	< 0.3 %/°C			
Zero drift*	< 1 mmHg/hour			
Frequency response*	0-25 Hz			
Aortic / Distal pressure output scale	5 µV/V/mmHg			
Aortic / Distal pressure output excitation	DC: Max ± 10 V, AC: max 8 Vrms up to 5000 Hz			
Aortic / Distal pressure output excitation impedance	1.5 kOhms			
Aortic / Distal pressure output signal impedance	1 kOhm			
Aortic / Distal pressure output phase shift	< 5 ° at 5 kHz			
Aortic / Distal Output Connection	Cathlab-specific cable			
Aortic / Distal output overall deviation	< 1 mmHg			
Aux pressure input scale	100 mmHg/V			
Aortic pressure input scale	5 µV/V/mmHg			
Electrical specifications		OU supply	DU Supply (DU-10" and DU-15")	
Classification	Class II with functional ground		Class I	
Isolation level	2xMOPP		2xMOPP	
Operating voltage	100-240 V, 50-60 Hz		100-240 V, 50-60 Hz	
Rated current (AC)	0.6 A		1.4 A	
Rated current (DC)	1.5 A / 12 VDC		6 A / 20 V	
Rated Power Consumption	20 W max		120 W max	
Dimensions	Optical Unit	Display Unit 10"	Display Unit 15"	Handle Unit
Height	165 mm / 6.50"	170 mm / 6.69"	280 mm / 11.02"	38 mm / 1.50"
Depth	65 mm / 2.56"	38 mm / 1.50"	48 mm / 1.89"	89 mm / 3.50"
Width	150 mm / 5.91"	262 mm / 10.31"	363 mm / 14.29"	75 mm / 2.95"
Weight	615 g	1500 g	4900 g	145 g (w. cable)
Environmental conditions				
Operating temperature	15 °C to 30 °C (59 °F to 86 °F)			
Operating atmospheric pressure	70 to 106 kPa (525 to 795 mmHg)			
Relative humidity operating	30 – 75 % RH			

IP Rating	IPX0 for HU and DU, IPX2 for OU		
Transport/storage atmospheric pressure	50 to 106 kPa (375 to 795 mmHg)		
Transport/storage temperature	-25 °C to 60 °C (-13 °F to 140 °F)		
Transport/storage humidity	10 – 85 % non-condensing		
Applied part	OptoWire™ (not supplied)	Type CF	
	SavvyWire™ (not supplied)	Type CF	
	Aortic transducer (not supplied)		

*Includes the effect of both the OptoMonitor 3 and OpSens pressure guidewire

13 ORDERING INFORMATION

Order Number	Descriptions
F2310	OptoMonitor 3 Optical Unit
F232011	OpM3-OU Power supply cable
F201004	AC Power cord - C13 to P5-15P hospital grade (NA)
F201006	AC Power cord - C13 to IEC884 (Europe)
F201005	AC power cord - C13 to B1346 (UK)
F201008	AC Power cord - C13 to JIS8303 (Japan)
F201011	AC power cord - Australia hospital grade; 2.5 meters
F201013	AC Power cord - KOREA 227 KETIIEC 2.5 meters
F201014	AC Power cord - C13 to P5-15P hospital grade (NA)-10ft
F201015	AC Power cord - Israel (SI 32)
F2320	OpM3-DU Display Unit - 10"
F2321	OpM3-DU Display Unit - 15"
F2322	OpM3-DU Wireless dongle
F2330	OpM3-HU Handle Unit
F232009	OpM3 DU-OU communication RS-232 cable (DU-10")
F232010	OpM3 DU-OU communication LAN cable (DU-15")
F232012	OpM3-DU 10" Power supply cable
F232039*	OpM3-DU 15" Power supply cable
F20110**	AUX interface cable (Cathlab dependant)
F20120**	Pressure output cable (Cathlab dependant)
F20130**	Ao transducer interface cable (Cathlab dependant)
F232028	Activation key FFR-dPR only
F232029	Activation key TAVI only
F232030	Activation key TAVI + FFR-dPR

*Power supply for DU-15" is dependant of the model used.

**Interface cables are dependent on the hemodynamic system used in your Cathlab; contact OpSens at 1.418.781.0333 or info@opsensmedical.com for the specific interface cables.

14 OPTOMONITOR 3 SYSTEM LOG – DISTAL INPUT VALUE



Dear valued customer,

The OptoMonitor 3 System log is used for recording the OptoMonitor 3 Distal Input value (diagnostic value) on the initial installation. We recommend that you fill out the log and keep it in a file for reference for your system maintenance. This log file serves as a comparative baseline for your future maintenance purpose.

Parameter	Descriptions	Typical signal with Reference Probe	Poor signal
Lamp (%)	Lamp driving level	70 %	100 %
Contrast (%)	Optical signal contrast visibility level	50 %	< 35 %
SNR	Signal to noise ratio	> 4000	< 2000
Gain	Signal Maximal Amplitude	1.7	> 2.20
Δ nm	Difference in nm between the Distal Input value and the Maintenance reference probe.	$\leq \pm 8$ nm	$> \pm 8$ nm

Authorized staff name				
Date of Verification				
Optical Unit SN #				
Display Unit SN #				
Atmospheric pressure (external source) (unit)				
Lamp level (%)				
Lamp Shunt (mV)				
Vpeak (mV)				
Vsignal (V)				
Vtemp (mV)				
Gain				
Mano (mmHg)				

Mano Supply (V)				
Contrast (%)				
SNR				
Reference probe SN#				
Reference Probe value (nm)				
Distal Input value (nm)				
Distal Input Delta (nm)				

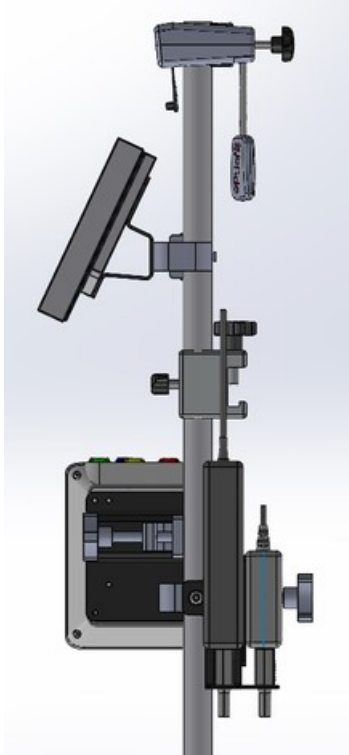

15 Appendix A: OptoMonitor 3 Installation Instructions

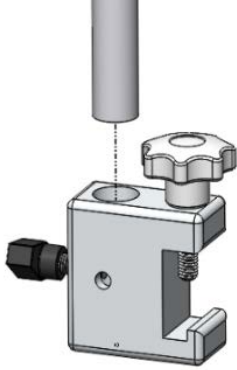
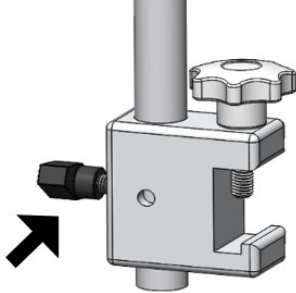
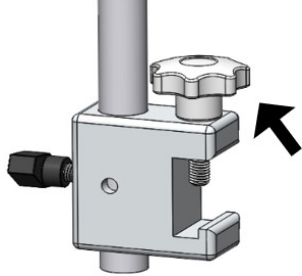

The following instructions give explanations on how to install the HU, DU, OU and PSU on the bedrail. Please note that this is a suggested installation.

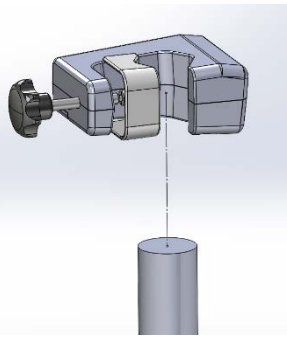
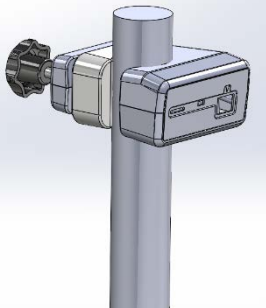
Assembly 1	Step 1	Step 2	Step 3
Installing the Bedrail Post Clamp on the IV pole			
Instructions	Insert the IV pole in the Bedrail post clamp	Tighten the clamping handle on the back of the Bedrail post clamp.	Slide the Bedrail post clamp on the bedrail, adjust the pole accordingly, and tighten the clamping handle on the bottom of it.

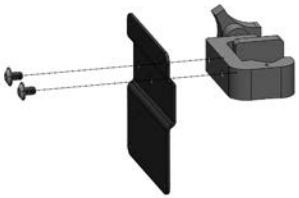
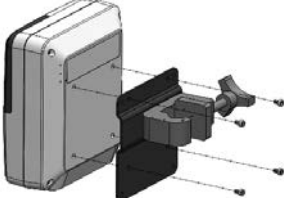
Assembly 2	Step 1	Step 2
Installing the OpM3-HU on the OU/DU 2ft pole		
Instructions	Insert pole in the OpM3-HU	Tighten the clamping handle

Assembly 3	Step 1	Step 2	Step 3
Installing the OpM3-OU on the OU/DU 2ft pole			
Instructions	Screw the plate to the C-Clamp	Screw the metal plate to the OU with 4 screws.	Insert pole in the C-Clamp and tighten the clamping handle

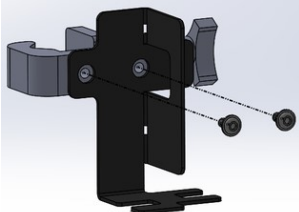
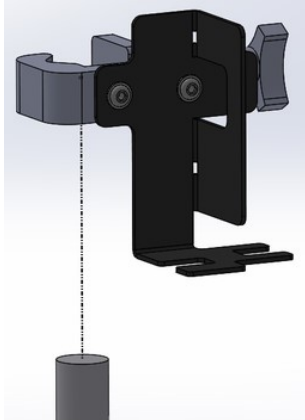
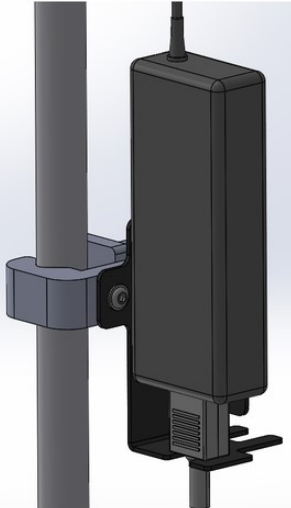
Assembly 4	Step 1	Step 2	Step 3
Installing the PSU mount for C-Clamp on the IV pole			
Instructions	Screw PSU mount for C-Clamp to the C-Clamp	Insert the pole in the C-Clamp and tighten the clamping handle	Make sure the PSU mount for C-Clamp is mounted with the cable passage towards the bottom. This helps maintain the power cord and avoid accidental disconnection. The PSU mount for C-Clamp can hold 2 power supplies.

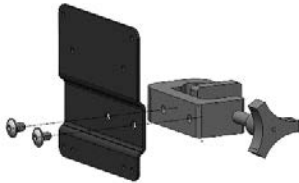
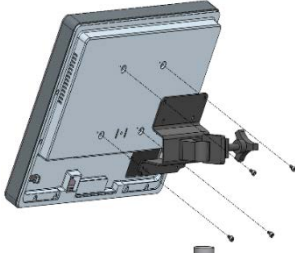
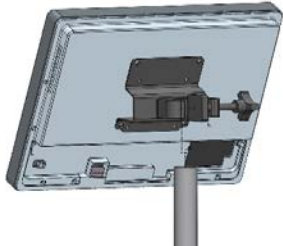
Assembly 5	Step 1	Step 2	Step 3
Installing the OpM3-DU 15 on the IV pole			
Instructions	Screw the plate to the C-Clamp	Screw the plate to the back of the screen	Insert the pole in the C-Clamp and tighten the clamping handle

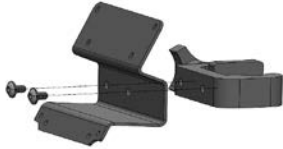
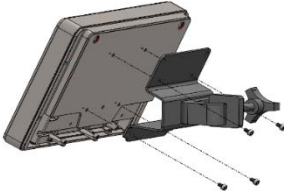
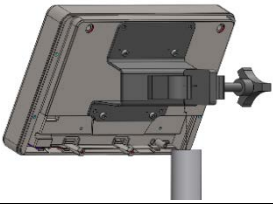
Assembly 6	Step 1	Step 2	Step 3
Installing the OpM3-DU 10 on the OU/DU 2ft pole			
Instructions	Screw the plate to the C-Clamp	Screw the plate to the back of the screen	Insert the pole in the C-Clamp and tighten the clamping handle

The following instructions give explanations on how to install the DU on the desk-stand, in the case where the DU is being installed in the Control Room of the catheterization laboratory.

Please note that this is an alternative installation to assembly 5 and 6.

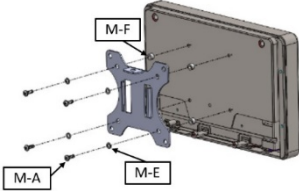
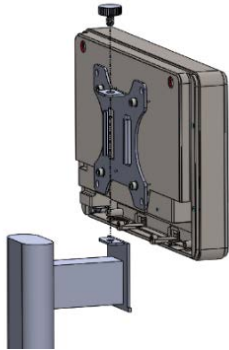
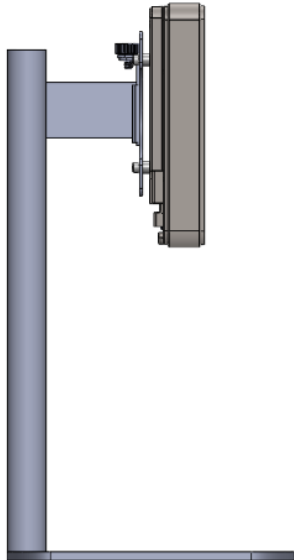
Assembly 7	Step 1	Step 2	Step 3
<p>Installing the OpM3-DU 10" on the desk stand</p>			
<p>Instructions</p>	<p>Attach the plate to the back of the screen.</p>	<p>Screw the plate to the base</p>	<p>Final view</p>

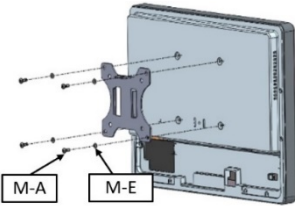
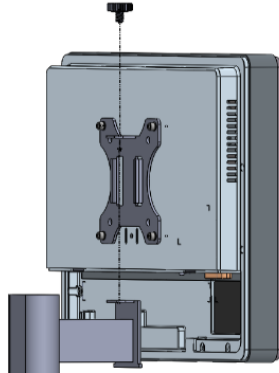
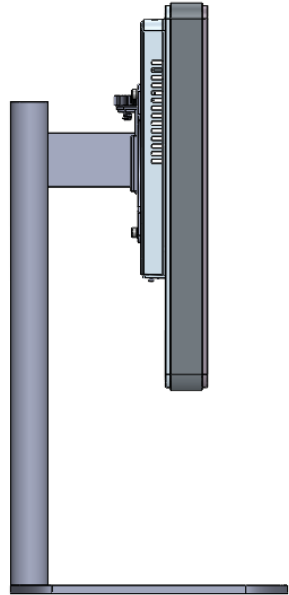
Assembly 8	Step 1	Step 2	Step 3
<p>Installing the OpM3-DU 15" on the desk stand</p>			
<p>Instructions</p>	<p>Attach the plate to the back of the screen.</p>	<p>Screw the plate to the base</p>	<p>Final view</p>

16 Parameters

Setting parameters shall be settled as follow, unless instructed otherwise by in-hospital personnel:

Averaging: **3** beats

Pressure scale: **0 - 150** mmHg or **0 - 200** mmHg

Time scale: **6** mm

Record: Proper parameterization is confirmed by initialing the Appendix B

17 AUX In Calibration Using the OptoMonitor 3 and Cathlab Hemodynamic System

Cable Connection

- Pd output cable connects to BP1 Hemo channel; BP1 is the patient aortic transducer pressure input channel
- Pa input cable connects to Hemo high level output port. High level output is 100 mmHg/V

1. Navigate to the Maintenance screen via the SETTINGS screen. Press “Input/Output Calibration” button located in the middle of the top row of the screen. Ensure “Pa Source” is set to “Aux”.
2. In the “Pd Out” box, click the “Output (mmHg)” drop-down menu and select “0”.
3. Zero Cathlab BP1 channel.
4. Ensure that “Reading (mmHg)” in the “AUX In” box shows “0.0”. If it does **not**, adjust the offset values until “Reading (mmHg)” shows “0.0”. When this occurs, proceed to step 5.
5. Next, in the “Pd Out” box, click the “Output (mmHg)” drop-down menu and select “200”. Check the Cathlab screen and ensure that Cathlab Pa is between 180-220 mmHg.
6. In the “AUX In” box, ensure that “Reading (mmHg)” shows a value ± 1 from what is being shown on the Cathlab screen. (e.g., if Cathlab reads 196 mmHg, “OptoMonitor 3 shall read between 195 mmHg and 197 mmHg.) If it does **not**, adjust the gain values of “AUX In” until “Reading (mmHg)” is within ± 1 of the Cathlab measurement.
7. Calibration complete. Record any Offset/Gain values in Appendix B.

18 Pa Input Calibration Using OptoMonitor 3 and Aortic Transducer

Aortic Transducer is not required however input gain can be adjusted.

19 Pd Output Calibration

Pd output calibration is performed with the system connected in its final configuration i.e.: with OptoMonitor 3 Pd output connected to its dedicated hemodynamic input.

Cable Connection

- Pd output connected to dedicated Hemo input (e.g. BP2).
- Pa input cable connects to high level Hemo output. Hemo high level output is 100 mmHg/V.

1. Navigate to the maintenance screen via the SETTINGS screen. Press the “Input/Output Calibration” button located in the middle of the top row of the screen. Ensure “Pa Source” is set to “Aux”.
2. In the “Pd Out” box, verify that “Output (mmHg)” is set to “0”, Offset is set to “0” and Gain is set to “1.00”.
3. Perform Cathlab input zero.
4. Check the Cathlab reading. Ensure that it is showing zero for Pa (within ± 1 mmHg). If it is not, adjust the offset values in the “Pd Out” box until it does.
5. Next, in the “Pd Out” box, set the “Output (mmHg)” to “200”.
6. Check that the Cathlab Pa measurement is within ± 1 mmHg of 200 mmHg. If it is not, adjust “Pd Out” gain value until Cathlab is reading 200 mmHg within ± 1 mmHg.
7. Calibration complete. Record any Offset/Gain values in Appendix B.

20 Aortic Output Calibration

Cable Connection

- Pa output cable connects to aortic transducer input.
- Pa input cable connects to aortic transducer output.

1. Navigate to the maintenance screen via the SETTINGS screen. Press the “Input/Output Calibration” button in the middle of the top row of the screen. Ensure “Pa Source” is set to “Transducer”.
2. NOTE: Changes to the Pa output Offset are avoided in an effort to not alter pressure data that will be sent to the Cathlab.
3. In the “Aortic Transducer Output” box, verify that “Output (mmHg)” is set to “0”, and Gain is set to “1.00”.
4. Perform Cathlab input zero
5. In the “Aortic Transducer Output” box, set “Output (mmHg)” to 200 mmHg.
6. Check the reading on the Cathlab. Ensure that the Cathlab is showing 200 mmHg, ± 1 mmHg. If it is **not**, adjust the “Aortic Transducer Output” gain until it is.

7. Calibration complete. Record any Gain values in Appendix B.

21 Installation Acknowledgement

After installation is completed, in-hospital representative should sign completed Appendix B.

22 Appendix B- Installation Checklist

Representative: (First name, Last name)	
Date (YYYY-MM-DD):	

Site information			
Hospital name:			
Cath lab #: (If applicable)			
OptoMonitor 3 Equipment			
Item #	Equipment	Included	Serial Number / Lot Number
F2310	Optical Unit (OU)	<input type="checkbox"/>	
F2320/F2321	Display Unit (DU)	<input type="checkbox"/>	
F2330	Handle Unit (HU)	<input type="checkbox"/>	
Instruments settings verified			
Averaging Period Setting:	3	<input type="checkbox"/> Yes	<input type="checkbox"/> No
Graph Pressure:	0 to 150 or 0 to 200		
Time scale:	6		
I/O	Final OFFSET adjustment value	Final GAIN adjustment value	
Aortic Transducer Input Reference	N/A		
Aux Input Reference			
Distal Output Reference			
Aortic Output Reference	N/A		
Correct Pa Source Selected for Aortic Input Type?		<input type="checkbox"/> Yes	<input type="checkbox"/> No
Aortic Input Reference calibration performed according to IFU?		<input type="checkbox"/> Yes	<input type="checkbox"/> No
Distal Output Reference calibration performed according to IFU?		<input type="checkbox"/> Yes	<input type="checkbox"/> No
Aortic output Reference and calibration performed according to IFU?		<input type="checkbox"/> Yes	<input type="checkbox"/> No

Signature: _____

For further information, please call OpSens at 1.418.781.0333 or visit www.opsensmedical.com

Corporate Headquarters:



OpSens Inc.
750 Boulevard du Parc Technologique
Quebec QC G1P 4S3 Canada
E-mail: info@opsensmedical.com
www.opsensmedical.com

The Bluetooth® word mark and logos are registered trademarks owned by Bluetooth SIG Inc. and any use of such marks by [licensee name] is under license. OptoWire™ and SavvyWire™ are registered trademarks owned by OpSens Inc. Other trademarks and trade names are those of their respective owners.



Manufactured By: OpSens Inc., 750 Boulevard du Parc Technologique, Quebec QC G1P 4S3, Canada T. :+1.418.781.0333 - www.opsensmedical.com



Authorized European Representative: MDSS GmbH, Schiffgraben 41, 30175 Hannover, Germany



Australian Sponsor: Emergo Australia, 201 Sussex Street, Darling Park, Tower II, Level 20, Sydney NSW 2000, Australia



Authorised representative for Switzerland: MedEnvoy Switzerland, Gotthardstrasse 28, 6302 Zug, Switzerland

©2023 OpSens, Inc. All rights reserved. Specifications are subject to change without notice.